

model ADHT-Ex intrinsically safe dewpoint transmitter



instruction manual

alpha house, 96 city road

bradford BD8 8ES

england

T 01274 733100

F 01274 733200

E-mail info@amsystems.co.uk

Web www.amsystems.co.uk

MODEL ADHT-Ex TRANSMITTER

INDEX

SPECIFICATION SHEET	PAGE 1
INSTALLATION (SAMPLE CONDITIONING)	PAGE 2 & 3
INSTALLATION (MTL 5042)	PAGE 4 & 5
INSTALLATION (MTL 2441B)	PAGE 6 & 7
OPERATION / MAINTENANCE	PAGE 8
DRAWINGS	
HAZARDOUS AREA CERTIFICATION FOR MODEL ADHT-EX	
HAZARDOUS AREA CERTIFICATION FOR INDICATOR (if applicable)	

dewSMART™ Model ADHT-Ex
Intrinsically Safe Dewpoint Transmitter

CE



Features :-

- **3 Wire, 4-20mA, 24V Dewpoint Transmitter**
- **Intrinsically Safe - CENELEC EEx ia IIC T6**
 **ATEX II 1G**
- **Overall Range -110°C to +20°C Dewpoint**
- **Accuracy ± 2°C Dewpoint (or equivalent)**
- **Calibrated in °C, °F or ppm(v)**
- **Polarity Protected Input**
- **Weatherproof Rating - IP65**
- **Open / Short Circuit Detection**
- **Built-in Temperature Compensation**
- **High Resolution Measurement Circuitry**
- **Calibration Traceable to National & International Standards**



The Alpha Moisture Systems **Model ADHT-Ex** is a 3 wire, 4-20 mA, 24V powered dewpoint transmitter. The unit is fully self contained in a robust stainless steel casing with weatherproof protection to IP65, making it ideal for use in heavy industrial environments.

Designed with the operator in mind, **Model ADHT-Ex** is extremely easy to use and the digital **dewSMART™** technology ensures accurate and reliable readings with little or no maintenance.

Model ADHT-Ex is certified intrinsically safe to EEx ia IIC T6 for use in hazardous areas using a MTL 2441B signal isolator for 110V AC or 240V AC operation, or MTL 5042 for 24V DC operation.

Various ranges are available covering an overall range from -110°C to +20°C dewpoint. The **Model ADHT-Ex** derives its power directly from the signal isolator and it is configured to give a linear 4-20mA signal for the chosen range.

The 4-20mA output signal can be transmitted up to 1000 meters to either DCS,SCADA system or any other suitable equipment with an input impedance of less than 600Ω.

Model ADHT-Ex is supplied ready for use, with calibration certificate traceable to National & International Humidity standards, instruction manual and 10 metres of connecting cable.



Alpha House, 96 City Road
Bradford BD8 8ES England
Telephone: 01274 733100
Facsimile: 01274 733200
E-mail: info@amsystems.co.uk
Web: www.amsystems.co.uk



SPECIFICATIONS - dewSMART™ Model ADHT-Ex

SENSOR

MODEL : ADHT Aluminium Oxide, Ultra High Capacitance dewSMART™ sensor with IP65 connector.

RANGE : Overall Range -110°C to +20°C dewpoint or 0.01 to 23000ppm. (Other engineering units available)

ACCURACY : ± 2°C Dewpoint (3 Sigma RSS)

OPERATING TEMPERATURE RANGE : -20°C to +60°C

STORAGE TEMPERATURE : -40°C to +80°C

TEMPERATURE COEFFICIENT : Temperature compensated for operating range.

RESPONSE TIME : Wet to Dry : -20°C to -60°C - less than 60 secs. Dry to Wet : -110°C to -20°C - less than 20 secs

SAMPLE FLOW RANGE : Flow independent but ideally 2 to 5 sl/min

CALIBRATION : Supplied calibrated with traceability to NPL. (NPL traceability for range -75°C to +20°C)

RECOMMENDED RECALIBRATION PERIOD : 1 Year

REPLACEMENT SENSOR : Completely interchangeable

ELECTRICAL

TRANSMITTER TYPE : 3 Wire Type Transmitter

OUTPUT SIGNAL : 4 to 20mA Linear suitable for external equipment with a maximum input impedance of 600 Ω (@ 24V) (Dependant on isolator selection)

MAXIMUM HAZARDOUS AREA CABLE LENGTH : > 200m
Dependant on cable parameters and hazardous area classification

Hazardous Area Cable Parameters when using MTL 2441B or MTL 5042 signal isolators/repeaters.

Gas Group	µF	mH	or	µH/Ω
IIC	0.13	4.3		55
IIB	0.39	12.6		165
IIA	1.04	33.6		440

MAXIMUM SAFE AREA CABLE LENGTH : 1000m

CABLE TERMINATIONS : IP65 rated connector at the sensor and other end terminated with bootlace ferrules.

ELECTROMAGNETIC COMPATIBILITY (EMC)

Immunity : Complies with EN 50082-1 : 1992
Emissions : Complies with EN 50081-1 : 1992

INTRINSIC SAFETY

Standard : EN 50014:1992 / EN50020:1994
Code : ATEX II 1G / EEx ia IIC T6
Certificate No. : SIRA99ATEX2096X

For full safety description please request the above certificate.

WARRANTY : 2 years for faulty workmanship and defective parts.

Ordering Information

CODE	RANGE
PL	-110° to +20°C
SR	-110° to -20°C
BL	-80° to +20°C
GY	-80° to 0°C
RD	-80° to -20°C
YW	-60° to 0°C
GD	-50° to +20°C
GN	-30° to +20°C

Example : If your requirement is for Dewpoint Transmitter with a range of -80°C to -20°C dewpoint then please order as : **Model ADHT-Ex-RD**

Sensor Holder (OPTIONAL)

Model DSH -

Fittings 1/4" OD pipe.....	4
Fittings 6mm OD pipe.....	6
Fittings 1/8" OD pipe.....	8
With port for Pressure Gauge.....	P

Corrosive Gases

The Sensor should not be exposed to corrosive gases (or corrosive contaminants in the main gas sample) as they would chemically attack the sensor and render it useless. Examples of such gases are mercury (Hg), ammonia (NH₃), chlorine (Cl₂) and wet acid vapours i.e. acid vapours in gas with moisture content greater than 100ppm(v). Strong oxidising agents such as ozone (O₃) should also be prevented from coming into contact with the sensor.

Installation

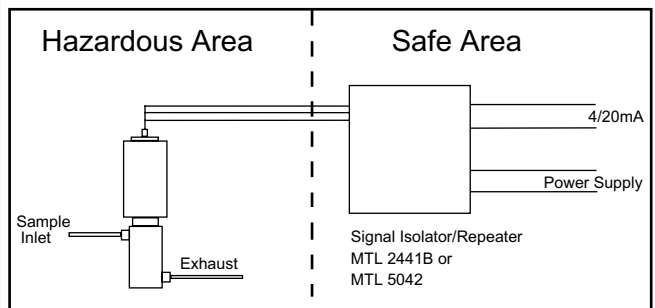

Note: Samples should be taken from the upper surface of the main line to prevent any risk of condensate reaching the sensor. Additional components may be required for specific applications - refer to *Accessories* and *Sampling System* specification sheets. Use stainless steel, nickel or copper piping wherever possible.

WEIGHTS & DIMENSIONS

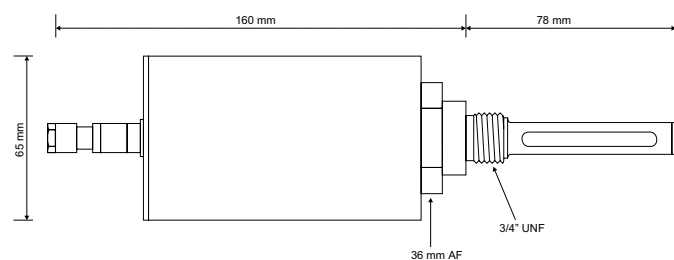

Allow a minimum of 60mm above the sensor body for plug and cable.

Weight : 830gms

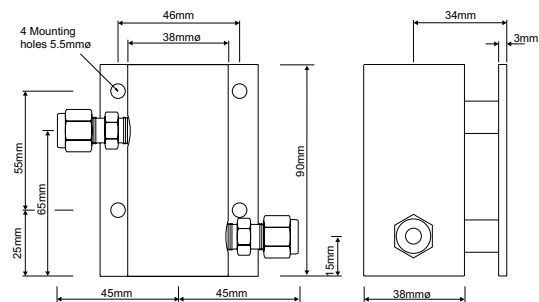

INSTALLING THE AIR/GAS SAMPLING SYSTEM

The piping installation schematic diagram on page 3 of this manual, shows all components which could be used in a dry gas measurement application although all items shown will not be required for every installation.

Care should be taken to ensure that the sample presented to the measuring sensor is not contaminated with any component that will damage, contaminate or affect the sensor in a way that will impair the system accuracy.

It is strongly recommended that the sample should not contain particulate matter, oil or other heavy hydrocarbon condensate. If these components contaminate the sample system and/or the measuring sensor the system response time will be lengthened, although the sensor calibration will not be affected.

The sample must not contain Ammonia, Chlorine, Ozone or any wet acid vapours or liquid as these will permanently damage the sensor and impair the calibration accuracy.

The flow rate, although not critical to the sensor measurement, should be low enough to avoid abrasion to the sensor surface without being so low as to extend the system response time to an unacceptable level. In general, a flow rate of between 2 and 3 Sl/min will give the right balance.

The sensor is a variable capacitor which is directly affected by changes in partial pressure of water vapour and these changes, which are proportional to the dew/frost point temperature are represented by the linear 4/20mA output.

Partial pressure of water vapour is directly affected by total pressure and, this being the case, the 4/20mA output will be proportional to the dew/frost point temperature at whatever total pressure the sensor is exposed, therefore care should be taken to ensure that the sample pressure, at the sensor is that at which the dew/frost point readings are required.

Where a sensor is calibrated to read absolute moisture content (e.g. ppm(V)) it is essential that this is done at a given operating pressure and that this pressure is maintained in the normal process operation. Failure to maintain this pressure will result in read-out errors.

The measuring sensor can be installed directly into the process line, but this does create problems with access for maintenance and calibration. It is for these reasons that we recommend that the sensor be installed in a bypass, fast loop or total loss sample system where the sensor is accessible without interrupting the main process flow line.

Component Index

1. **Sample Isolation Valve.** This is a recommended item as it allows access to the sample system without interrupting the main process line.
2. **Sample Tube.** This should be stainless steel for dry air or gas applications but copper or carbon steel can be used where wetter gases are to be measured. If any section of the sample tube must be flexible then PTFE should be used. In most cases 3mm OD (1/8") is sufficient as it provides good system response time with minimum flow. 6mm OD (1/4") tube can be used where pressure drops across 3mm tube are too high.
3. **Filter Unit.** A filter unit is recommended when samples are likely to contain particulate matter. If the air/gas sample contains heavy hydrocarbon condensate this must be of the coalescing type with drain. The filter unit should be positioned as close to the sample point as practical.
4. **Pressure reducing Valve or Pressure Regulator.** If the sample is to be measured at atmospheric pressure then valve 4A should be fitted and 4B omitted from the system. If the sample is to be measured at full line and the exhaust vented to atmosphere then valve 4B should be fitted and 4A omitted from the system. If measurements are to be taken at full line pressure and the sample is to be returned to a part of the main line or vent which is at a pressure higher than atmospheric and the input to that line needs a controlled pressure then both valves 4A and 4B will be required.
5. **Sample Pressure Gauge.** This is not a critical part of the moisture measurement but may be required if Dew/Frost point measurements are to be made at higher than atmospheric pressure.
6. **Measuring Sensor.**
7. **Sensor Holder.**
8. **Desiccant Chamber.** This item is only required when the sampling is to be intermittent. When installed it prevents the ingress of wet air to the sample system, while the sample is not flowing, improving response time.
9. **Flow Control Valve.** This can be a separate item or combined with the flow indicator.
10. **Flow Indicator.** The recommended sample flow is 2/3 SL/M.
11. **Sample Exhaust.** The exhaust can be vented to atmosphere or returned to the process line as discussed above.

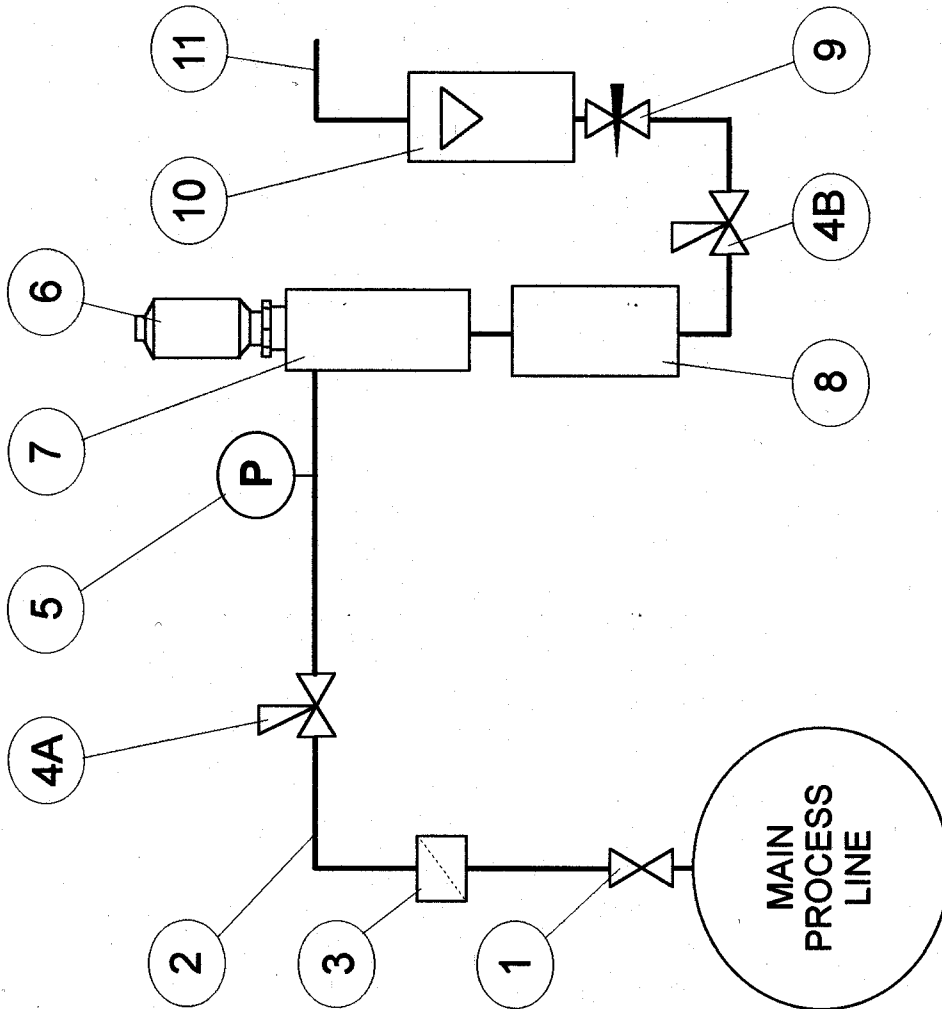

NOTES

- a. The sample point should be on the upper surface of a horizontal pipe, or from a vertical section of pipe, where ever possible.
- b. The sample tube should run upwards from the sample point. If this is not possible then an inspection port or drain tap stalled at the lowest point in the sample system.

INSTALLATION (USING MTL 5042)

Refer to drawings 941, 942 and 943 and select the system appropriate to this application and to the appropriate hazardous area certification, paying special attention to the whole of this section to ensure a SAFE installation.

SENSOR CABLE CONNECTOR TO TRANSMITTER

NOTE: The Plug and socket of the connector have location keys to ensure correct positioning. Care should be taken to ensure that correct alignment is made before attempting to mate the plug and socket or damage to the connector pins will occur, resulting in malfunction of the instrument.

Refer to drawing 1008.

If a new or replacement cable assembly has to be manufactured, ensure that the diagram is followed exactly and no connections are made to pins other than 1, 3 and 7.

NOTE. The other pins of the 7 pin connector, are only used in a SAFE area and must not, on any account, be used in the HAZARDOUS are. Failure to follow this instruction will invalidate the hazardous area certification and render the transmitter UNSAFE.

THE MTL 5042 ISOLATOR/REPEATER

Refer to drawing 940.

This drawing identifies the terminal numbers and there function. Follow these instructions carefully when wiring the device into the system.

WARNINGS

1. Carry out all installation work in accordance with the relevant instruction given in a nationally accepted code of practice for intrinsically safe installations.
2. Do not install isolators in hazardous areas unless they are housed in an enclosure approved for the area concerned.
3. Mount isolators (and enclosures) in a clean, dry environment, shielded from direct sunlight and other sources of heat.
4. Take great care to keep hazardous area and safe area wiring segregated when wiring isolators, whether un-enclosed or within enclosures.
5. Do not use chemical cleaning solvents.

MOUNTING THE MTL 5042 ISOLATOR/REPEATER

Clip the MTL 5042 onto type T35 DIN rail, with the blue signal plugs facing towards the hazardous area wiring.

To remove an isolator from the rail, insert a screwdriver into the sliding clip and lever the clip gently outwards. Pivot the isolator off the rail.

WIRING THE MTL 5042 ISOLATOR/REPEATER

Depending on the installation, it may be easier to wire up the isolator with the power and signal plugs in place, or removed. In either case, allow sufficient free cable to easily permit plug removal for future operations.

Making connections:-

- a. Trim back the insulation of conductors by 12mm.
- b. Check the terminal assignments shown on drawing 940.
- c. Insert the conductors according to the terminal assignments and tighten the screws.

NOTE. If wiring is to be fitted with crimp ferrules, the trimmed conductor length should be 14mm.

INSTALLATION (USING MTL 2441B)

Refer to drawings 1001, 1002 and 1003 and select the system appropriate to this application and to the appropriate hazardous area certification, paying special attention to the whole of this section to ensure a SAFE installation.

SENSOR CABLE CONNECTOR TO TRANSMITTER

NOTE: The Plug and socket of the connector have location keys to ensure correct positioning. Care should be taken to ensure that correct alignment is made before attempting to mate the plug and socket or damage to the connector pins will occur, resulting in malfunction of the instrument.

Refer to drawing 1008.

If a new or replacement cable assembly has to be manufactured, ensure that the diagram is followed exactly and no connections are made to pins other than 1, 3 and 7.

NOTE. The other pins of the 7 pin connector, are only used in a SAFE area and must not, on any account, be used in the HAZARDOUS are. Failure to follow this instruction will invalidate the hazardous area certification and render the transmitter UNSAFE.

THE MTL ISOLATOR/REPEATER

Refer to drawing 1000.

This drawing identifies the terminal numbers and there function. Follow these instructions carefully when wiring the device into the system.

WARNINGS

1. Carry out all installation work in accordance with the relevant instruction given in a nationally accepted code of practice for intrinsically safe installations.
2. Do not install isolators in hazardous areas unless they are housed in an enclosure approved for the area concerned.
3. Mount isolators (and enclosures) in a clean, dry environment, shielded from direct sunlight and other sources of heat.
4. Take great care to keep hazardous area and safe area wiring segregated when wiring isolators, whether un-enclosed or within enclosures.
5. Do not use chemical cleaning solvents.

MOUNTING THE MTL 2441B ISOLATOR/REPEATER

Clip the MTL 2441B onto type T35 DIN rail, with the blue signal plugs facing towards the hazardous area wiring.

To remove an isolator from the rail, insert a screwdriver into one of the sliding clips and lever the clip gently outwards. Pivot the isolator off the rail.

WIRING THE MTL 2441B ISOLATOR/REPEATER

Depending on the installation, it may be easier to wire up the isolator with the power and signal plugs in place, or removed. In either case, allow sufficient free cable to easily permit plug removal for future operations.

Making connections:-

- a. Trim back the insulation of conductors by 12mm.
- b. Check the terminal assignments shown on drawing 1000.
- c. Insert the conductors according to the terminal assignments and tighten the screws.

NOTE. If wiring is to be fitted with crimp ferrules, the trimmed conductor length should be 14mm.

OPERATION / MAINTENANCE

The Model ADHT-Ex is designed to operate continuously and, providing that care has been taken with the initial installation, as discussed in pages 2 & 3 of this manual, the amount of routine maintenance necessary can be kept to a minimum.

It is advisable to periodically check that the correct pressures and flows are applied to the transmitters and that any filters installed are cleaned, drained or replaced as necessary.

Calibration verification of the transmitter output and sensor response curve is recommended at 12 monthly intervals.

If, for any reason, it is necessary to replace a Model ADHT-Ex, any other Model ADHT-Ex of the same measuring range is fully interchangeable.

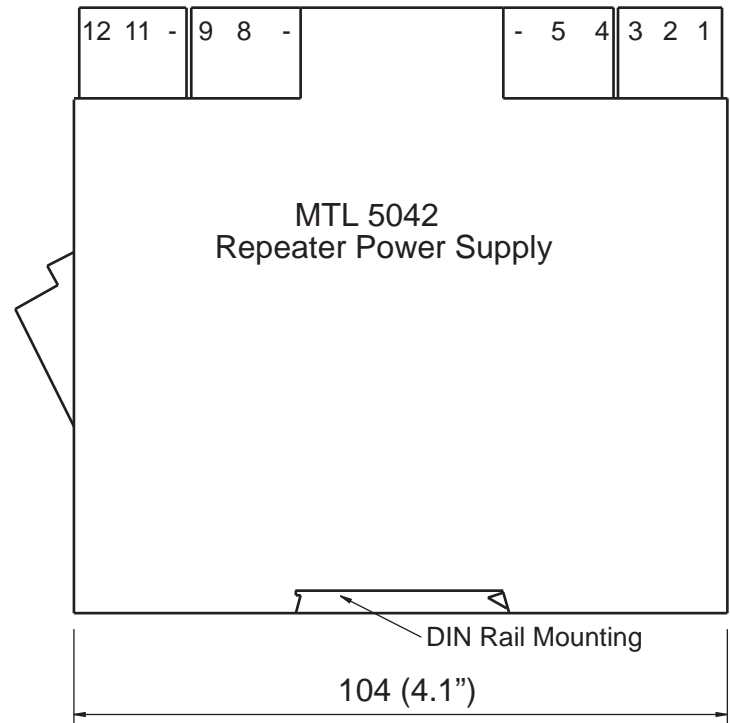
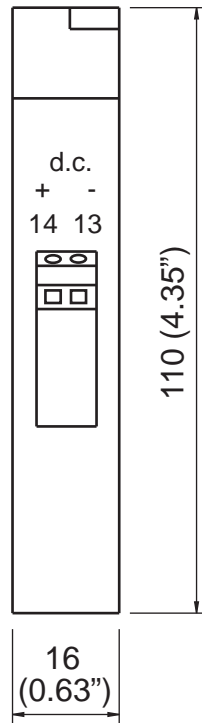
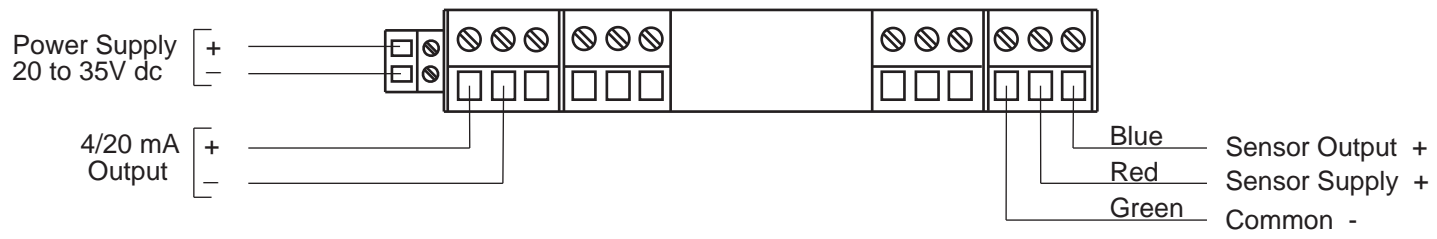

User Connections		Sensor Cable
1	Sensor Output +	Blue
2	Sensor Supply +	Red
3	Common -	Green
11	mA Output -	
12	mA Output +	
13	Power Supply -	
14	Power Supply +	

TITLE MTL 5042. Connection Details							
Issue	2	Rev	Auth	Date	Rev	Auth	Date
Auth	DLC	Mod		Mod		Material	
Date	12.12.01						

DRAWING No.	940
ASSOCIATED DRAWINGS	



Safe Area

Hazardous Area

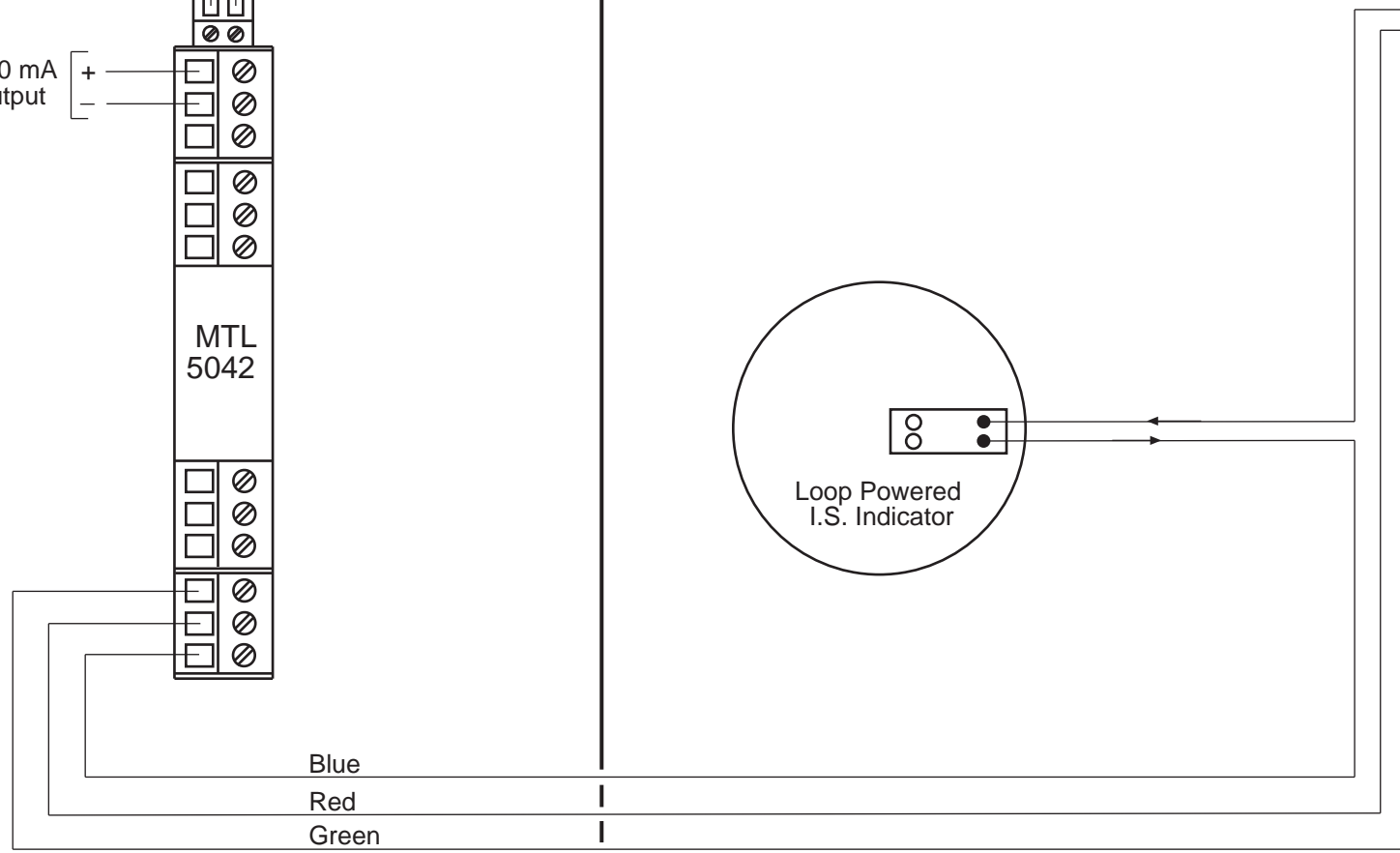
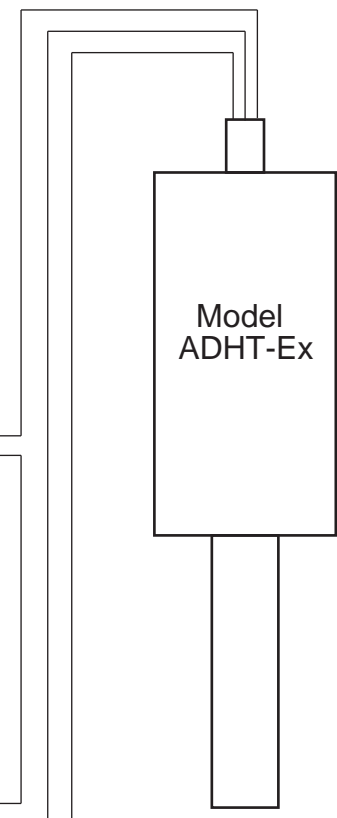
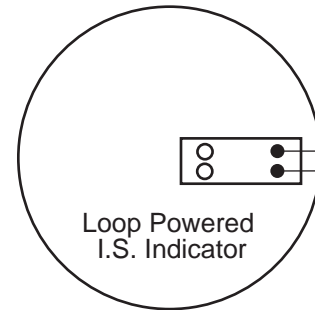
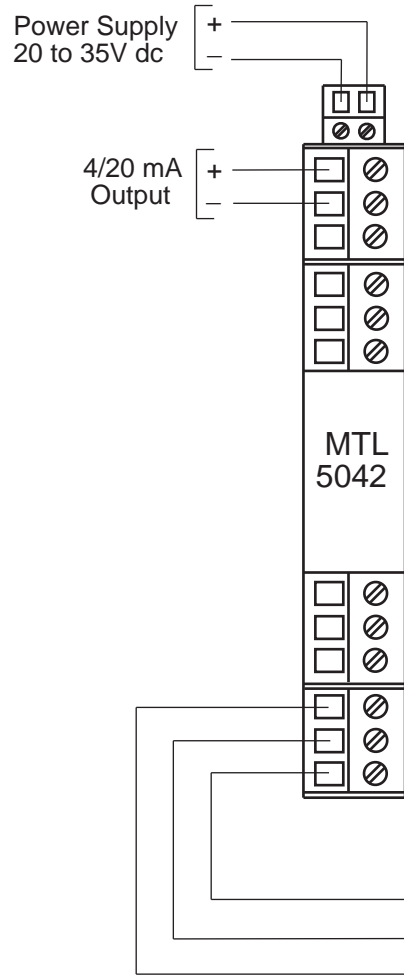

TITLE MTL 5042 ,ADHT-Ex & IS Indicator. Installation Schematic

DRAWING No. 942

Issue 2	Rev	Auth	Date	Rev	Auth	Date	Material
Auth DLC	Mods			Mods			
Date 12.12.01							

ASSOCIATED DRAWINGS
940 Connection Details



Safe Area

Hazardous Area

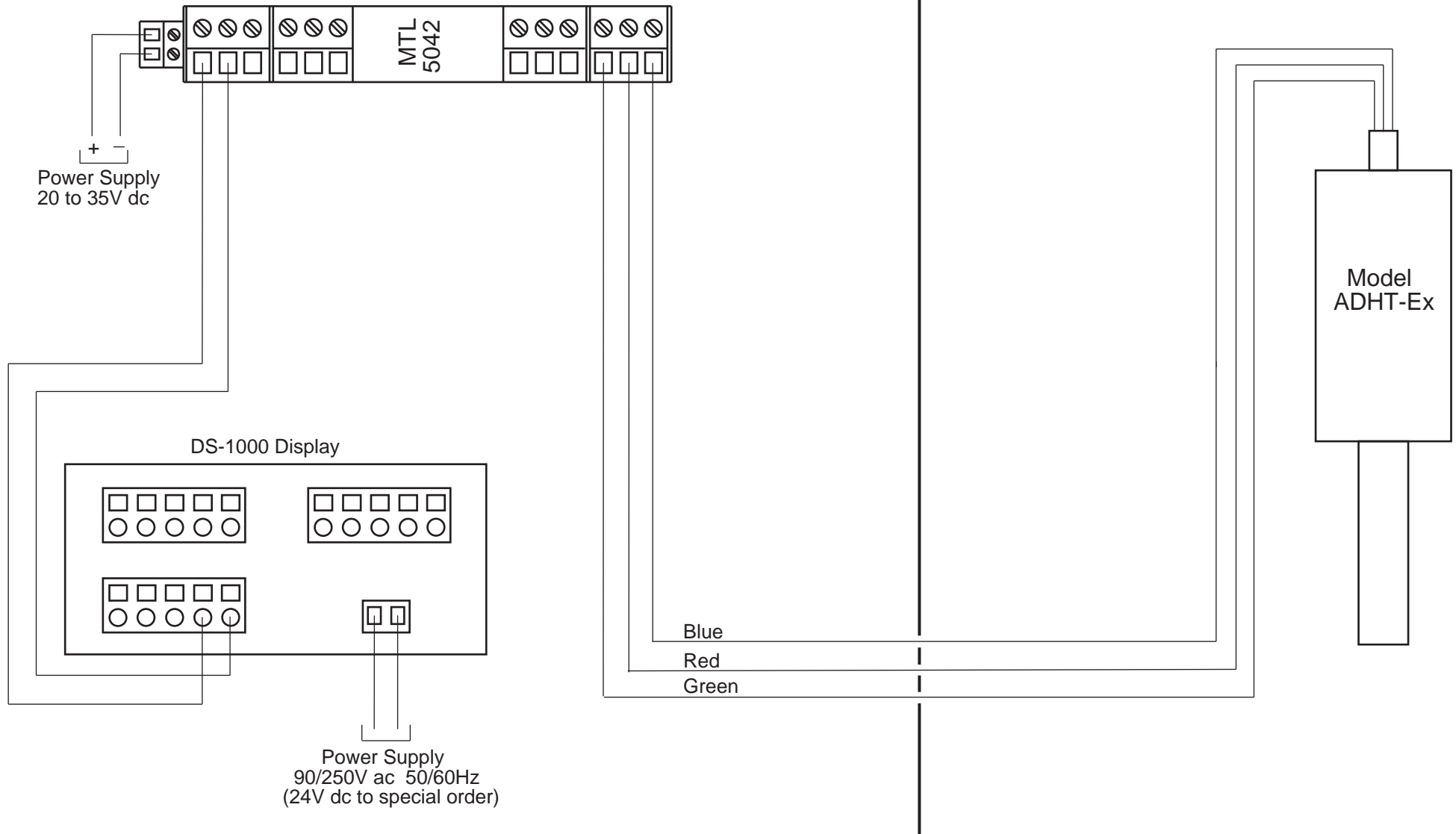

TITLE MTL 5042 ,ADHT-Ex & DS-1000 Indicator. Installation Schematic									
Issue	2	Rev	Auth	Date	Rev	Auth	Date	Material	
Auth	DLC	Mods			Mods				
Date	12.12.01								

DRAWING No.	943
ASSOCIATED DRAWINGS	940 Connection Details



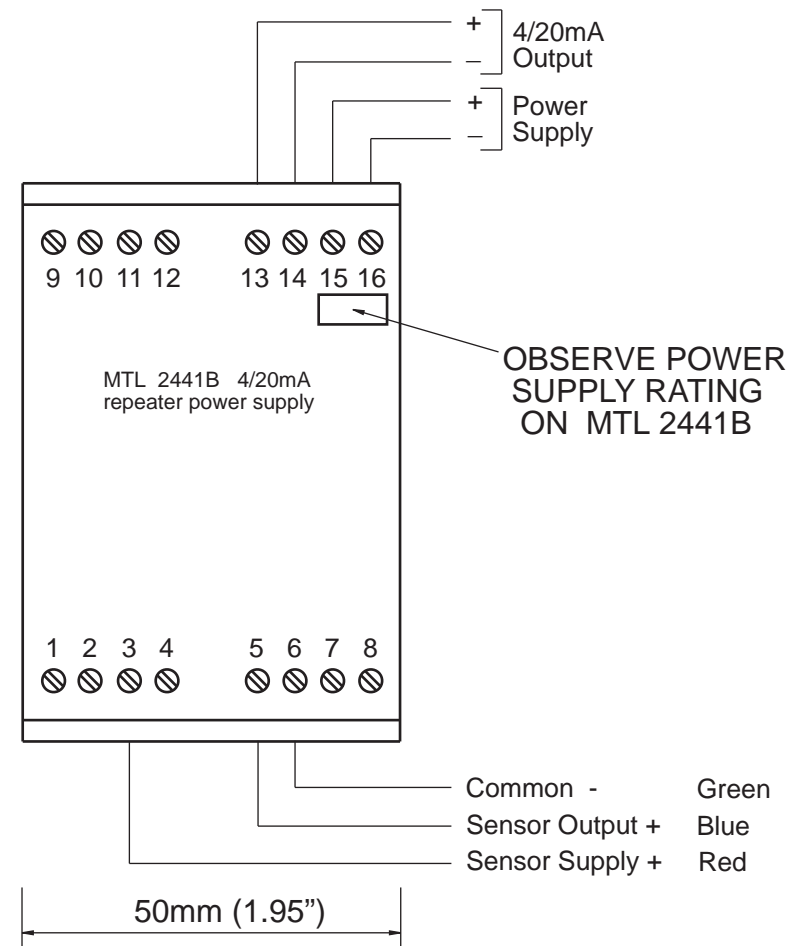
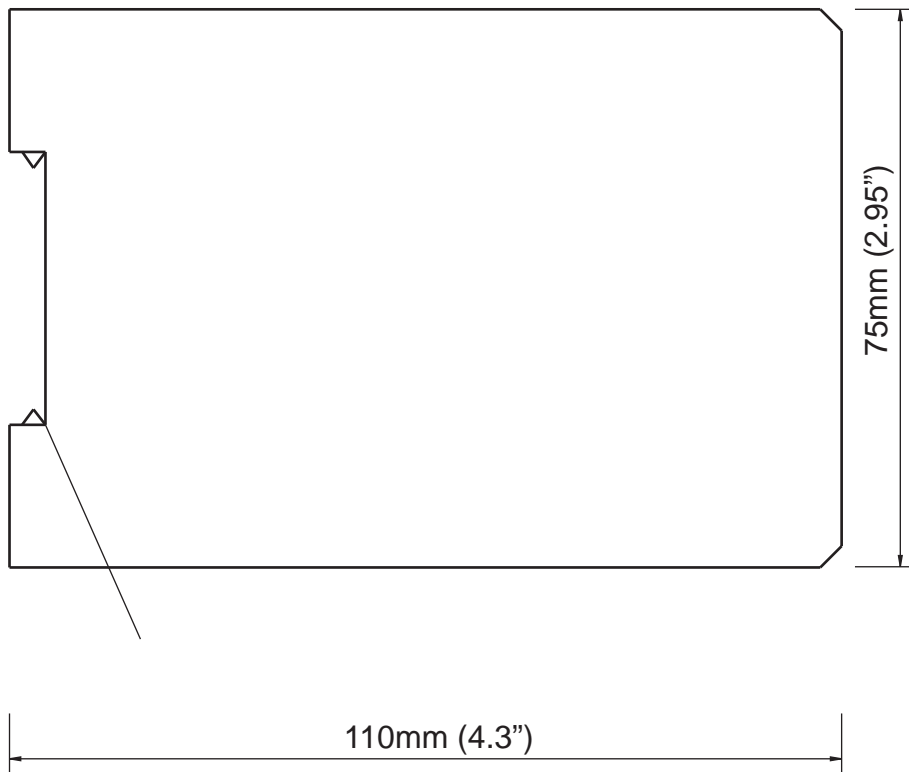

TITLE MTL 2441B Termination Details							
Issue	1	Rev	Auth	Date	Rev	Auth	Date
Auth	DLC	Mods		Material			
Date	12.12.01						

DRAWING No.	1000
ASSOCIATED DRAWINGS	



Hazardous Area

Safe Area

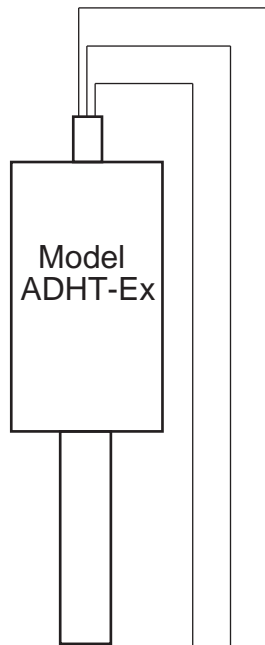

Red
Blue
Green

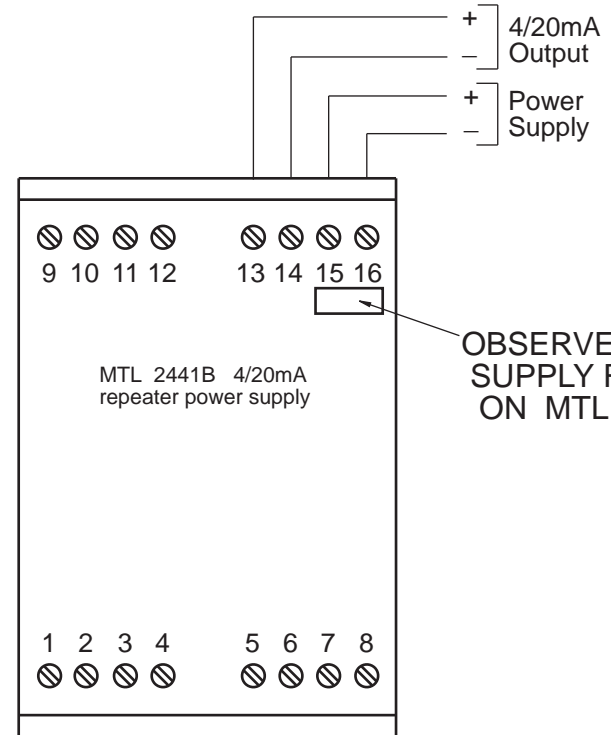

OBSERVE POWER
SUPPLY RATING
ON MTL 2441B

TITLE MTL 2441B & ADHT-Ex. Installation Schematic

DRAWING No.

1001

Issue 1	Rev	Auth	Date	Rev	Auth	Date	Material
Auth DLC	Mods		Mods				
Date 12.12.01							

ASSOCIATED DRAWINGS



Hazardous Area

Safe Area

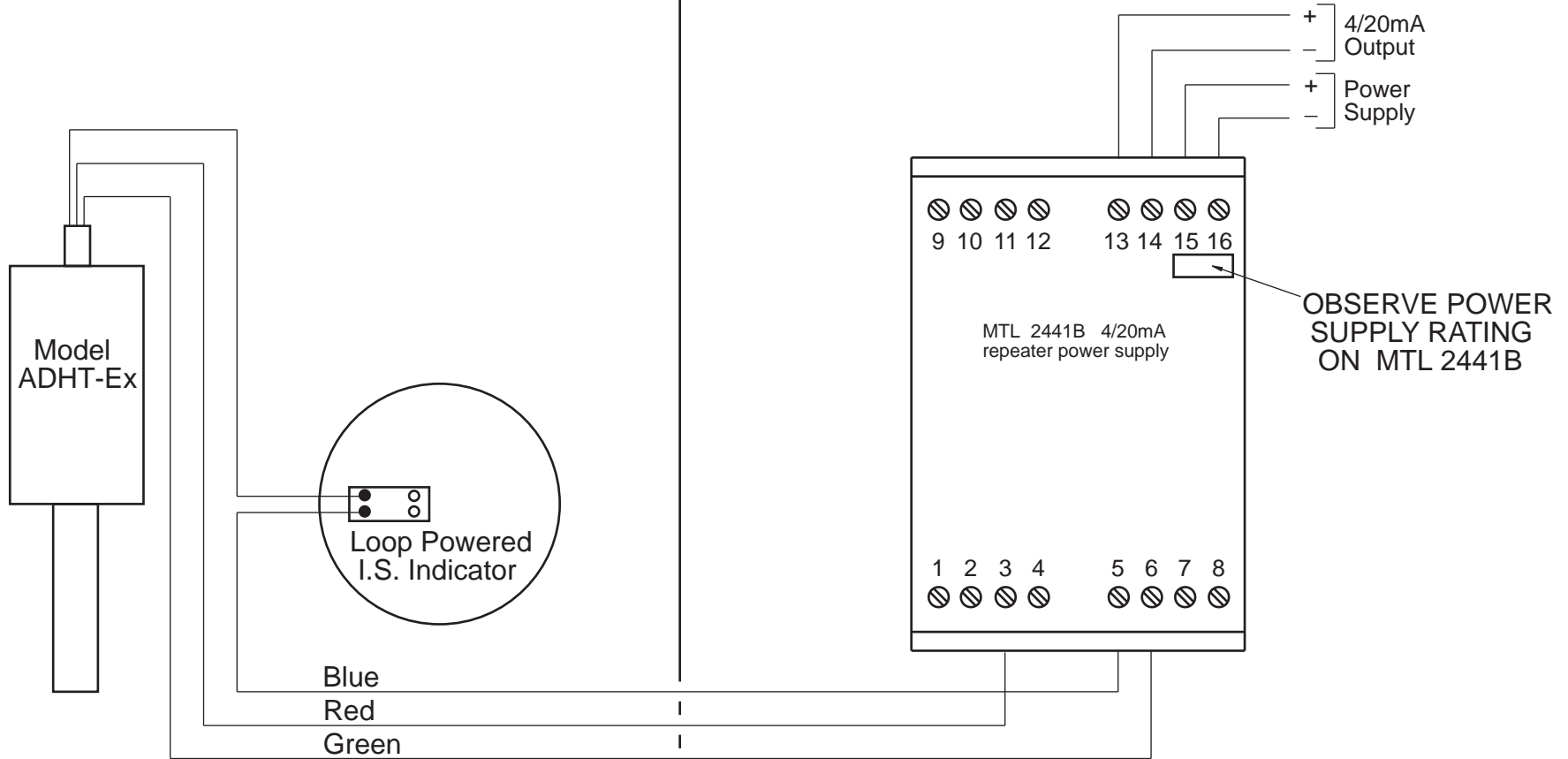

TITLE MTL 2441B, ADHT-Ex & I.S. Indicator. Installation Schematic

DRAWING No.

1002

Issue	1	Rev	Auth	Date	Rev	Auth	Date	Material
Auth	DLC	Mods		Mods				
Date	12.12.01							

ASSOCIATED DRAWINGS



Hazardous Area

Safe Area

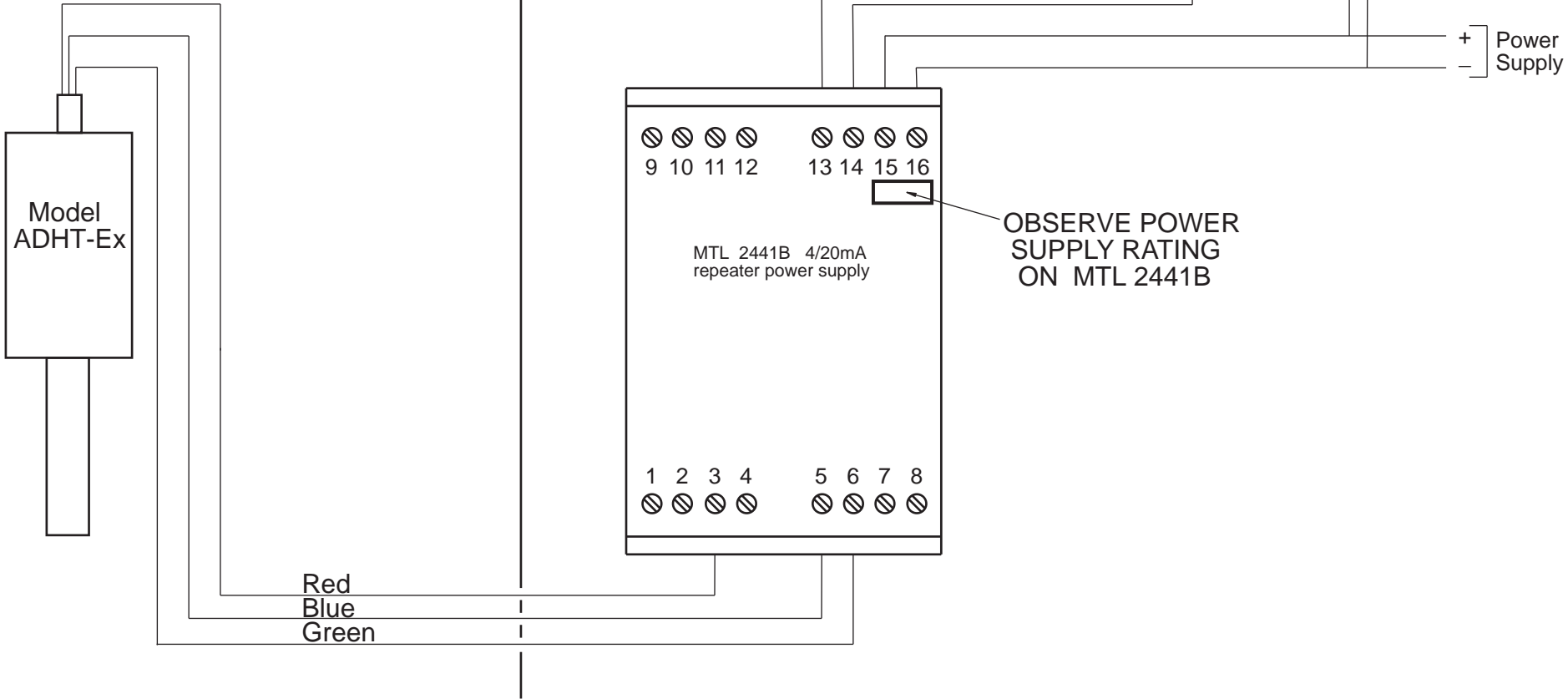

TITLE MTL 2441B, ADHT-Ex & DS-1000 Indicator. Installation Schematic

DRAWING No.

1003

Issue	1	Rev	Auth	Date	Rev	Auth	Date	Material
Auth	DLC	Mods		Mods				
Date	12.12.01							

ASSOCIATED DRAWINGS



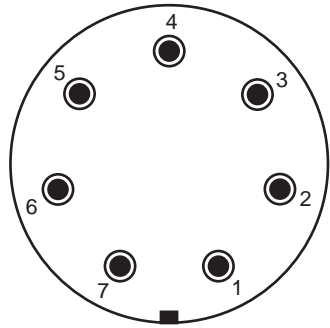

Cable Socket
Inside view of solder buckets

USER CONNECTIONS		
Pin	Function	Colour
1.	24V dc +	Red
3.	Common -	Green
7.	mA Output +	Blue

Important Note
Do not make connections to any unidentified pins

Locking Collar

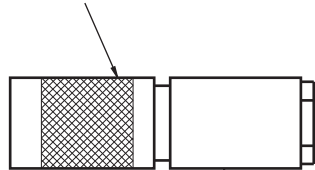

Sensor Connection Socket

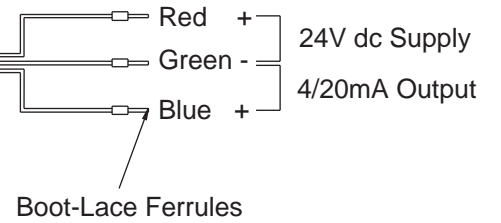
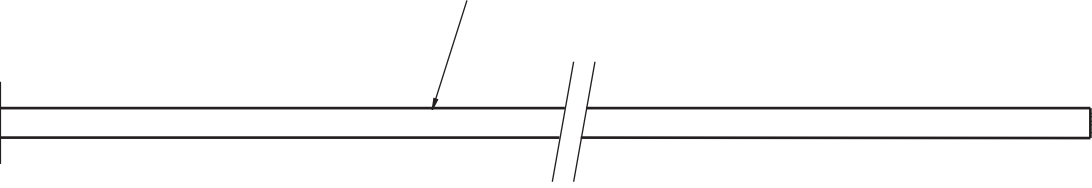

TITLE Model ADHT-Ex. Cable Assembly. User Connctions							
Issue	2	Rev	Auth	Date	Rev	Auth	Date
Auth	DLC	Mods		Material			
Date	12.12.01						

DRAWING No.	1008
ASSOCIATED DRAWINGS	





1 **EC-TYPE EXAMINATION CERTIFICATE**

2 Equipment intended for use in Potentially Explosive Atmospheres Directive 94/9/EC

3 Certificate Number : SIRA99ATEX2096X

Classification Index : 13

4 Equipment: DewSMART™ Intrinsically Safe 4-20 mA Dewpoint Transmitter
 Model ADHT-Ex

5 Applicant : Alpha Moisture Systems

6 Address : Alpha House
 96 City Road
 Bradford
 BD8 8ES
 England

7 This equipment or protective system and any acceptable variation thereto is specified in the schedule to this certificate and the documents therein referred to.

8 Sira Certification Service, notified body number 0518 in accordance with Article 9 of the Council Directive 94/9/EC of 23 march 1994, certifies that this equipment or protective system has been found to comply with the Essential Health and Safety Requirements relating to the design and construction of equipment and protective systems intended for use in potentially explosive atmospheres given in Annex II to the Directive.

The examination and test results are recorded in confidential report number R52X6047A.

9 Compliance with the Essential Health and Safety Requirements, with exception to those listed in the schedule to this certificate, has been assured by compliance with the following documents :

EN 50014:1997
EN 50020:1994

10 If the sign 'X' is placed after the certificate number, it indicates that the equipment or protective system is subject to special conditions for safe use specified in the schedule to this certificate.

Project Number 52X6047
Date 20 July 1999

M D Shearman
Certification Manager



EC-TYPE EXAMINATION CERTIFICATE NUMBER

SIRA99ATEX2096X

11 This EC-Type Examination Certificate relates only to the design and construction of the specified equipment or protective system. If applicable, further requirements of this Directive apply to the manufacture and supply of this equipment or protective system.

12 The marking of the equipment or protective system shall include the following:-



II 1 G

EEx ia IIC T6 (Ta = -40°C to +60°C)

Date 20 July 1999



SCHEDULE

EC-TYPE EXAMINATION CERTIFICATE NUMBER

SIRA99ATEX2096X

13

DESCRIPTION OF EQUIPMENT

The ADHT-Ex 4-20 mA Dewpoint Transmitter is designed to monitor the moisture content of gases. The information from these measurements is then transmitted to the non-hazardous area via a 3-wire transmission link.

The circuitry is potted within a stainless steel cylindrical enclosure with a projecting sensing element, which is protected by a sintered particle filter. The interface between the sensing element and the enclosure is type tested on a sample basis to 1000 bar. There is a single connector, which is normally connected to the associated apparatus but, in the non-hazardous area only, may be connected to a PC for downloading calibration data. It is therefore necessary to stipulate the maximum voltage/current when interrogating in the non-hazardous area.

The equipment has the following safety description:

Parameter	Value
U_i	28 V
I_i	120 mA
P_i	0.84 W
C_i	0
L_i	100 μ H

14

DESCRIPTIVE DOCUMENTS

14.1	Drawing No.	Issue	Rev.	Sheet	Date	Title
	867	1	-	1 to 3	07 Jul 99	Dewsmart Sensor EXia
	870	1	-	1 of 1	07 Jul 99	ADHT-Ex Dewpoint Transmitter PCB Parts List
	871	1	1	1 of 1	07 Jul 99	ADHT-Ex Dewpoint Transmitter General Arrangement
	873	1	-	1 of 1	05 Jul 99	ADHT-Ex pcb to Connector Assembly
	878	2	-	1 of 1	02 Jul 99	ADHT-Ex IS Label Details

Date 20 July 1999



SCHEDULE

EC-TYPE EXAMINATION CERTIFICATE NUMBER

SIRA99ATEX2096X

14.2 Report NoR52X6047A composed of 8 pages, 2 appendices and 7 drawings.

15 **SPECIAL CONDITIONS FOR SAFE USE** (*denoted by X after the certificate number*)

15.1 The user should note that the circuit is connected to the enclosure and account of this should be taken at installation.

16 **ESSENTIAL HEALTH AND SAFETY REQUIREMENTS OF ANNEX II (EHSR'S)**

The table below lists all relevant EHSR's not addressed by the standards listed in this certificate. These EHSR's have been assessed in report no. R52X6047A

Annex II Clause Number	Title
1.1.2	Effect of explosive atmosphere on materials

17 **CONDITIONS OF CERTIFICATION**

17.1 The use of the Sira Certification Service Mark is subject to the Regulations Applicable to Holders of SCS certificates.

17.2 This certificate relates only to the apparatus specified herein as executed in the samples supplied for evaluation.

17.3 In affixing the Sira certificate number to the apparatus the applicant attests on his own responsibility that the apparatus conforms to the documents listed herein.

If the marked apparatus is found not to comply Sira Certification Service should be notified immediately at its offices at South Hill, Chislehurst, Kent BR7 5EH, England.

Date 20 July 1999

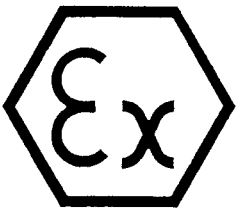

QUALITY ASSURANCE NOTIFICATION

SCHEDULE

Explosion protection concepts for which the manufacturer has been assessed

ia, ib intrinsic safety

Equipment categories for which the manufacturer has been assessed

sensors and transducers

Notification No : SIRA 99 ATEX M040
Date of issue : 23 August 1999



STATUS INSTRUMENTS LTD

050892

00P0305/6

23 March 2000

CERTIFICATE OF CONFORMANCE **NO. 8094**

ALPHA MOISTURE SYSTEMS

Alpha House
96 City Rd
BRADFORD
W.Yorks
BD8 8ES

This is to certify that the following items have been assembled and tested to drawings approved by BASEEFA, and have been inspected and tested in accordance with the conditions and requirements of the contract or purchase order, and unless otherwise noted below, conform in all respects to the specification(s), drawing(s) relevant thereto.

Description	Serial Number	Certificate No.	Class
DM400X/2 X -100/-20°C 1 X -60/0°C	087426-1/3	BAS Ex90C2062	EEx ia IIC T5

DM400X Loop powered indicator must be used as part of an approved system.

A certificate of assurance for a suitable temperature transmitting system, approval No. Ex83432 is available from Status Instruments Ltd.

This certificate does not imply that the apparatus meets all statutory requirements for any particular industry or circumstance.

Signed

For and on behalf of Status Instruments Ltd

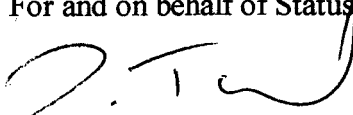
PP PEGGY LEWIS

QUALITY CO-ORDINATOR