

**ZIRCONIA OXYGEN
ANALYZER CONVERTER**

TYPE: ZRY

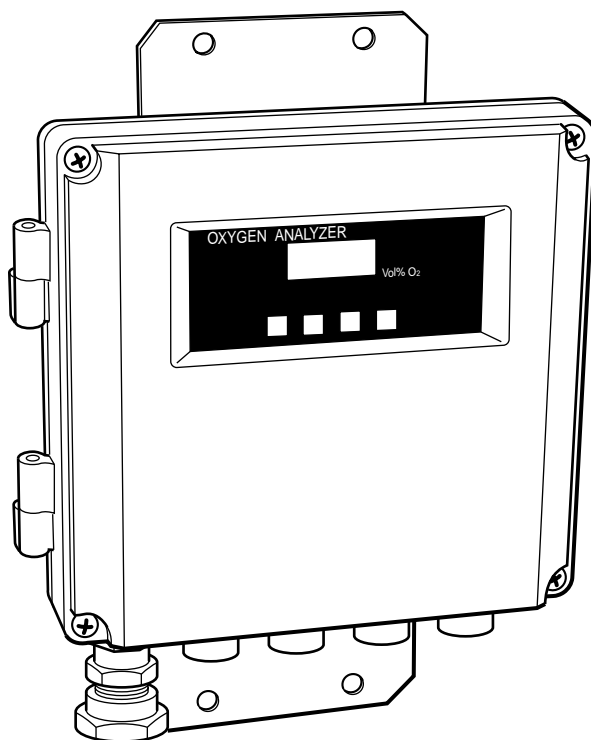

PREFACE

We are grateful for your purchase of Fuji Electric's Zirconia Oxygen Analyzer Converter (ZRY).

- First read this instruction manual carefully until an adequate understanding is acquired, and then proceed to installation, operation and maintenance of the analyzer converter. Wrong handling may cause an accident or injury.
- The specifications of this analyzer converter will be changed without prior notice for further product improvement.
- Modification of this analyzer converter is strictly prohibited unless a written approval is obtained from the manufacturer. Fuji Electric will not bear any responsibility for a trouble caused by such a modification.
- This instruction manual shall be stored by the person who actually uses the analyzer converter.
- After reading the manual, be sure to store it at a place easier to access.
- This instruction manual should be delivered to the end user without fail.

Manufacturer: Fuji Electric Co., Ltd.
Type: Described in Fuji Electric's company nameplate on main frame
Date of manufacture: Described in Fuji Electric's company nameplate on main frame
Product nationality: Japan

Request

- It is prohibited to transfer part or all of this manual without Fuji Electric's permission in written format.
- Description in this manual will be changed without prior notice for further improvement.



© Fuji Electric Co., Ltd. 1998

Issued in June, 1998
Rev. 1st edition April, 2000



CAUTION ON SAFETY

First of all, read this “Caution on safety” carefully, and then use the analyzer in the correct way.

- The cautionary descriptions listed here contain important information about safety, so they should always be observed. Those safety precautions are ranked 2 levels; DANGER and CAUTION.

 DANGER	<p>Wrong handling may cause a dangerous situation, in which there is a risk of death or heavy injury.</p>
 CAUTION	<p>Wrong handling may invite a dangerous situation, in which there is a possibility of medium-level trouble or slight injury or only physical damage is predictable.</p>

- Even an undesirable action described in “  **CAUTION**” may lead to a grave result depending on situation. Be sure to observe DANGER and CAUTION because they are both important for ensuring safety.

Caution on installation and transport of gas analyzer	
 DANGER	<ul style="list-style-type: none"> This unit is not explosion-proof type. Do not use it in a place with explosive gases to prevent explosion, fire or other serious accidents.
 CAUTION	<ul style="list-style-type: none"> This unit should be installed in a place which conforms to the conditions noted in the instruction manual. Otherwise, it may cause electric shocks, fire or malfunction of the unit. During installation work, care should be taken to keep the unit free from entry of cable chips or other foreign objects. Otherwise, it may cause fire, trouble or malfunction of the unit. For installation, observe the rule on it given in the instruction manual and select a place where the weight of gas analyzer can be endured. Installation at an unsuited place may cause turnover or fall and there is a risk of injury. For lifting the gas analyzer, be sure to wear protective gloves. Bare hands may invite an injury. Before transport, fix the casing so that it will not open. Otherwise, the casing may be separated and fall to cause an injury. The gas analyzer is heavy. It should be transported carefully by two or more persons if manually required. Otherwise, body may be damaged or injured.

Caution on piping	
 DANGER	<ul style="list-style-type: none"> If leaked gas contains oxygen at a high concentration, there is a risk of fire. Connect pipes correctly referring to the instruction manual. Wrong piping may cause gas leakage.

Caution on wiring



CAUTION

- The unit must be earthed as specified. Otherwise, it may cause electric shocks, malfunction, etc.
- Be sure to use a power supply of correct rating. Connection of power supply of incorrect rating may cause fire.
- Wiring work must be performed with the main power set to OFF to prevent electric shocks.
- Use wiring materials that match the rating of the unit. Use of wiring materials out of rating may cause fire.

Caution on use



CAUTION

- During operation, avoid opening the casing and touching the internal parts. Otherwise, you may suffer a burn or shock hazard.
- Avoid touching the detector with bare hand during operation. Otherwise, you may suffer a burn because the detector may have reached a high temperature (about 800°C).
- During operation, avoid removing and placing the detector on or near a combustible material. Otherwise, fire may occur.

Caution on maintenance and check



CAUTION

- Before maintenance and check, be sure to turn off the main power supply and wait until the detector is cooled adequately. Otherwise, you may suffer a burn.
- Before removing the detector from the flue for maintenance and check, make sure the furnace is stopped. Otherwise, you may suffer a burn.
- Before working, take off a wrist watch, finger ring or the like metallic accessories. And never touch the instrument with a wet hand. Otherwise, you will have a shock hazard.
- If the fuse is blown, eliminate the cause, and then replace it with the one of the same capacity and type as before. Otherwise, shock hazard or fault may be caused.

Others



CAUTION

- If the cause of any fault cannot be determined despite reference to the instruction manual, be sure to contact your dealer or Fuji Electric's technician in charge of adjustment. If the instrument is disassembled carelessly, you may have a shock hazard or injury.
- Do not use a replacement part other than specified by the instrument maker. Otherwise, adequate performance will not be provided. Besides, an accident or fault may be caused.
- Replacement parts such as a maintenance part should be disposed of as incombustibles.

CONTENTS

PREFACE	i
CAUTION ON SAFETY	ii
CONTENTS	iv
1. GENERAL DESCRIPTION	1
1.1 Direct insertion type zirconia oxygen analyzer	1
1.2 Confirmation of delivered components	1
1.3 Confirmation of type of delivered components	1
2. NAME AND FUNCTION OF EACH PART	2
2.1 Name and function of converter part	2
2.2 Name and function of display and control panel	2
3. INSTALLATION	3
3.1 Location for installation	3
3.2 Installation	3
4. WIRING AND PIPING	4
4.1 Before wiring	4
4.2 Wiring to each terminal	4
4.3 Wiring and piping diagram	5
5. PREPARATION FOR OPERATION	6
6. OPERATION AND STOP	6
6.1 Starting	6
6.2 Shutdown	6
6.3 Key operation flow diagram (outline)	7
6.4 Check on alarm data	8
6.5 Oxygen detector standard output	8
7. SETTING OF CALIBRATION GAS CONCENTRATION	9
7.1 How to set span calibration gas concentration	9
7.2 How to set zero calibration gas concentration	9
8. CALIBRATION	10
8.1 Preparation	10
8.2 Manual calibration	10
9. RANGE SELECTION	11
10. ADJUSTMENT	12
10.1 Zirconia input signal adjustment	12
10.2 Temperature input adjustment	13
10.3 Current output adjustment	14
10.4 Setting of detector control temperature	15
10.5 Selection of alarm contact output	16
11. MAINTENANCE AND CHECK	17
11.1 Check	17
11.2 Fuse replacement	17
11.3 Troubleshooting	18
12. APPENDIX	19
12.1 Specification	19
12.2 Designation of type (PILC code table)	20
12.3 Outline diagram (unit:mm)	22

1. GENERAL DESCRIPTION

This instruction manual describes the installation, operation and maintenance of the single-channel type converter, so read through it before using the converter. For the sensor, flow guide tube used with the converter, refer to relevant instruction manuals.

1.1 Direct insertion type zirconia oxygen analyzer

The direct insertion type zirconia oxygen analyzer consists of a direct insertion type zirconia detector (type ZFK) and converter (type ZRY).

It is used to measure oxygen concentration in waste gas during combustion for controlling gas combustion.

1.2 Confirmation of delivered components

Inspect the external appearance and number of accessories to confirm there is no damage or shortage of parts.

List of components and accessories

Converter

Accessories of converter

- Power fuse (0.5A)----- 1
- Heater fuse (3A)----- 1



CAUTION

Power voltage for the converter must conform to that for the detector (ZFK2 or 5) to be connected. Don't use any power voltage different from the power specifications of the detector.

Because it may result in damage to the sensor.

100/115V AC for ZFK²□□ 14-0
⁵

200/220V AC, or 230V AC for ZFK²□□³4-0
⁵ ⁵

1.3 Confirmation of type of delivered components

Check model name on specification nameplate to confirm that the delivered components are as described in Item 12.2 Designation of type (PILC code table).

2. NAME AND FUNCTION OF EACH PART

2.1 Name and function of converter part

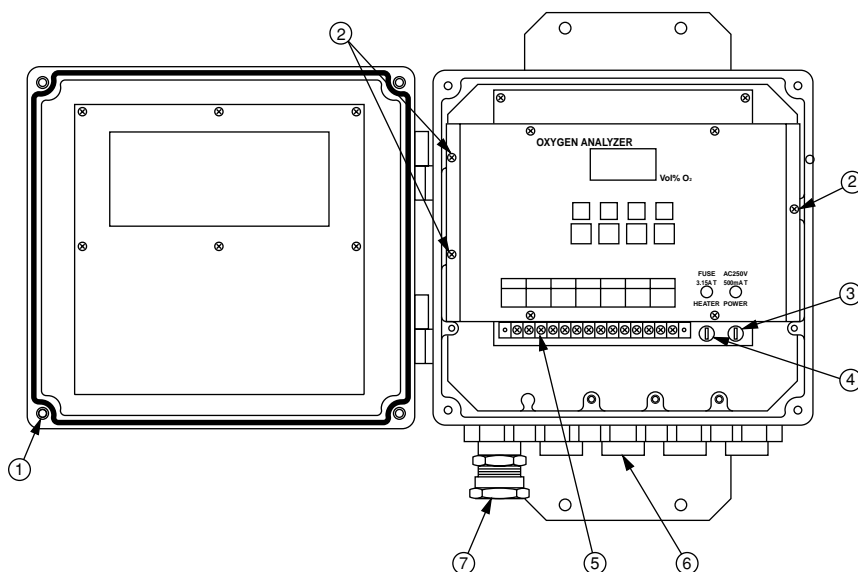

No.	Name	Function
①	Cover fixing screw (4 places)	Screw for opening or closing the cover.
②	Operation panel fixing screw (3 places)	Screw for fixing the operation panel to the case.
③	Fuse (0.5A)	Fuse for the power supply of the converter.
④	Fuse (3A)	Fuse for the heater for O ₂ sensor.
⑤	Terminal block	Connect cables from external equipments.
⑥	Cable inlet	Use to insert external cable.
⑦	Cable gland	Cable inlet to insert the exclusive cable for the sensor.

2.2 Name and function of display and control panel

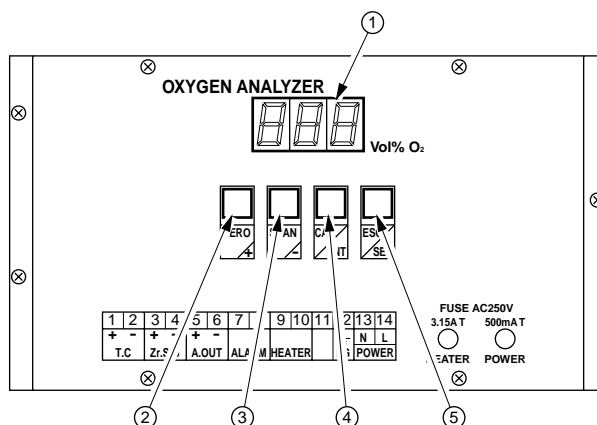

No.	Name	Function
①	Oxygen concentration display	Displays oxygen gas concentration.
②	ZERO key	} Refer to each operation procedure flow in chapter 6 to 10.
③	SPAN key	
④	CAL key	
⑤	ESC key	

3. INSTALLATION



CAUTION

- Install the analyzer safely and securely so that it will not fall.

3.1 Location for installation

The location for installation should meet the following conditions.

- (1) Space for routine inspection and wiring available.
- (2) Vibration, dust, dirt and humidity are minimal.
- (3) No direct influence of radiation from heating furnace or the like (converter).
- (4) Non-corrosive atmospheric environment.
- (5) No electric machinery nearby, which may cause noise trouble (such as motor, transformer) or produce electromagnetic and electrostatic induction.
- (6) Ambient temperature within -10 to +50°C and ambient humidity less than 90%RH (converter).

3.2 Installation

3.2.1 Panel mounting

Mounting dimension (unit ; mm)	Mounting method									
<p>4-M8 72 312</p>	<p>Panel face 3.2^t</p> <table border="1" data-bbox="912 1218 1334 1473"> <thead> <tr> <th>No.</th> <th>Name</th> <th>Piece</th> </tr> </thead> <tbody> <tr> <td>1</td> <td>Converter</td> <td>1</td> </tr> <tr> <td>2</td> <td>Pan head screw M8 (Excluded from the scope of supply)</td> <td>4</td> </tr> </tbody> </table>	No.	Name	Piece	1	Converter	1	2	Pan head screw M8 (Excluded from the scope of supply)	4
No.	Name	Piece								
1	Converter	1								
2	Pan head screw M8 (Excluded from the scope of supply)	4								

4. WIRING AND PIPING

⚠ CAUTIONS

- Wiring work must be carried out with all power supplies turned off. Otherwise, you may suffer electric shock.
- The analyzer should be grounded without fail (Class 3 grounding).

4.1 Before wiring

- ① Power supply voltage to the converter should match with that of the sensor (Type ZFK2 or 5).
- ② For wiring to the power supply, use 600V vinyl insulation power cable (JISC3307) of 1.25mm² or equivalent.
- ③ For the wiring of thermocouple, be sure to use a compensating wire.
- ④ Exclusive cable (6 cores in total) between the sensor and converter should be installed in a cable conduit for protection. It should be separated from power cable for prevention of noise. For use of the exclusive cable, see Item 12.2 Designation of type.
- ⑤ Output signal cable should be separated more than 30cm away from power line to prevent effect of induction noise. Shielded cables should be used and grounded at one point with M4 screw with toothed washer.

Note) When connecting cables to external terminal block, recommended insulation sleeve solderless terminals should be used (for M4 screw).

4.2 Wiring to each terminal

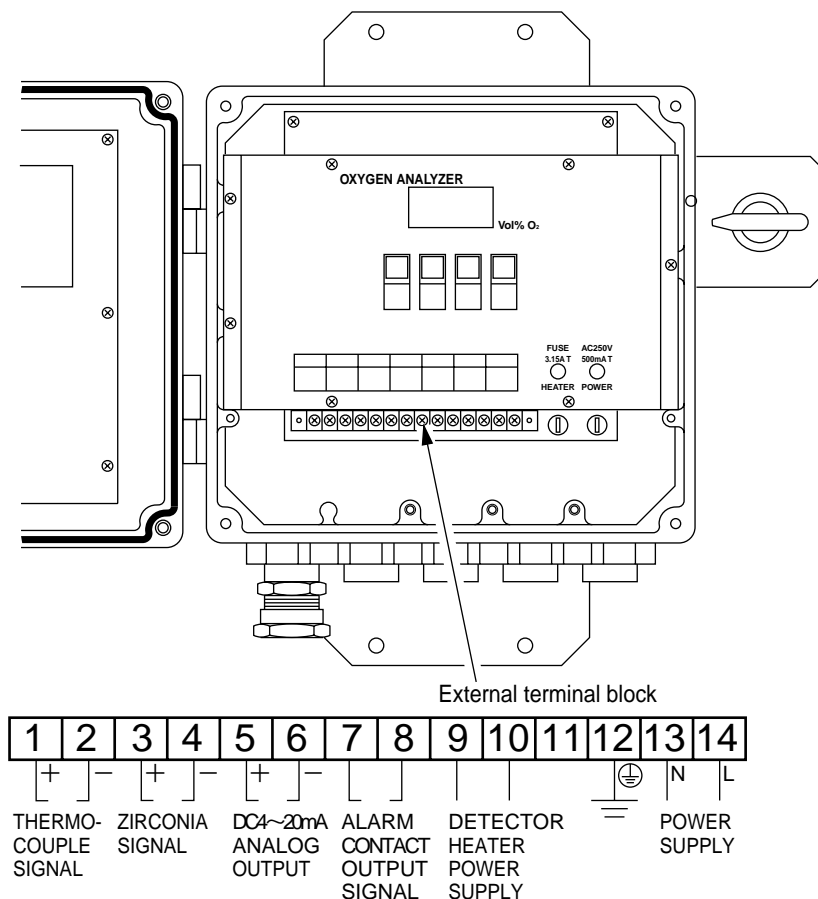

4.3 Wiring and piping diagram

With flow guide tube

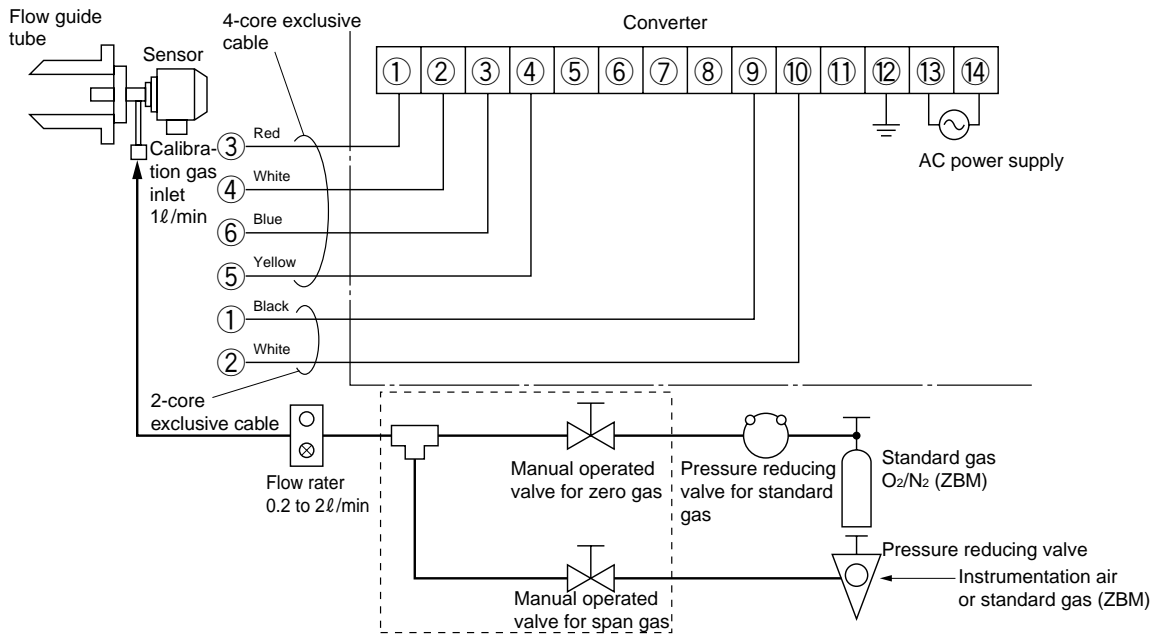

5. PREPARATION FOR OPERATION

Preparation can be performed after installation or on the bench.

① Wiring check (Refer to 4.2, 4.3)



② Confirmation of the power supply specifications (Confirm the specifications of the main power supply and voltage.)



③ Piping check (Refer to 4.3)



④ Power ON
• Turn ON the power
• LED lighted.
• The analyzer is set in measurement display mode after warm-up (15 minutes).



⑤ Warmup (After 15 minutes from power ON, accurate measurement data may be obtained.)



⑥ Standard gas (composition gas) concentration setting
For the standard gas concentration to be used, see Chapter 7.



⑦ Calibration
At the first operation, perform manual calibration after warmup using a calibration gas.
Refer to chapter 8 for calibration procedures.



Operation

6. OPERATION AND STOP

6.1 Starting

After correct wiring and piping has been completed, turn the converter power ON, and measuring operation will start.

Note : 15 minutes is required for warming-up after power ON.

Caution before starting operation

- ① Furnace operation should be started after 15 minutes. or more of warmup time has elapsed.
- ② When a sensor is to be installed in a furnace during operation, take care to blow out harmful gas from the furnace and then install the fully warmed up sensor quickly.

6.2 Shutdown

(1) When a process (furnace etc.) is to be shutdown for a short time (about one week)

The sensor should be operated continuously to avoid possible deterioration of platinum electrodes and destruction of its element by repeating power ON-OFF operation in a wet condition (depending on the condition in furnace and/or ambient conditions)

(2) When a process (furnace etc.) is to be shutdown for a long time

Turn OFF the analyzer after gas in the furnace has been replaced completely by ambient air.

6.3 Key operation flow diagram (outline)

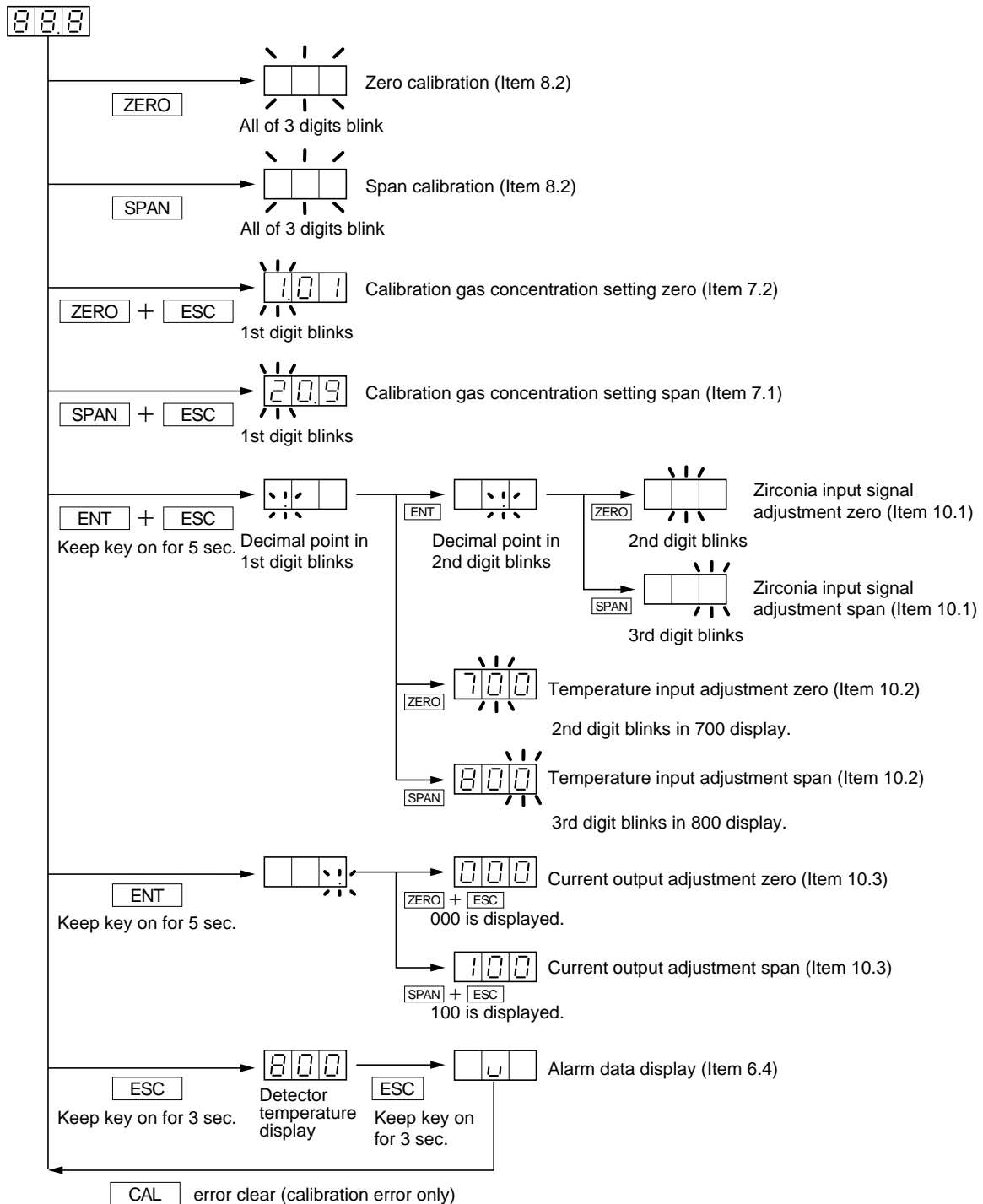

Note) How to cancel operation

Press the **ESC** key during setting to cancel operation midway, returning to measurement display.

6.4 Check on alarm data

When a fault (error) warning output appears at the converter alarm contact output terminals (No. 7 and No. 8), the alarm data can be checked by the following operation.

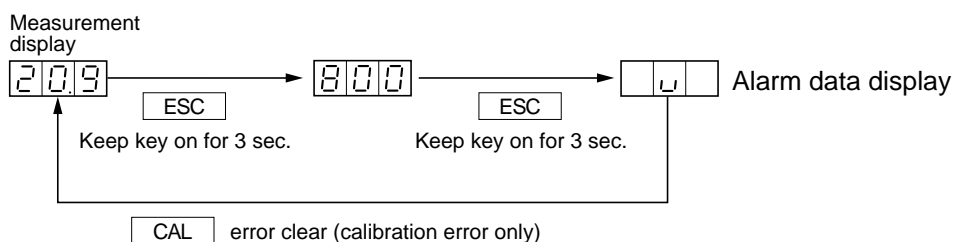

After checking the alarm data, press the **CAL** key and the alarm of zero/span calibration error will be cleared.

Alarm data

	The 3rd digit Temperature error	H ; 50°C (or more) higher than the detector control temperature L ; 50°C (or less) lower than the detector control temperature
	The 2nd digit Zero calibration error	L ; Difference of more than 5%O ₂ between zero calibration gas concentration and zero calibration set value Blank; Normal
	The 1st digit Span calibration error	L ; Difference of more than 5%O ₂ between span calibration gas concentration and span calibration set value Blank; Normal

Conditions of converter alarm contact output (between No.7 and No.8 terminals)

The 5th digit of converter code symbols	Power OFF	Power ON, normal	Power ON, alarm
B	Open	Open	Closed
C	Open	Closed	Open

6.5 Oxygen detector standard output

O ₂ concentration %	Output value mV	O ₂ concentration %	Output value mV	O ₂ concentration %	Output value mV
0.01	168.15	5.0	31.20	25.0	-4.266
0.1	117.41	10.0	15.93	30.0	-8.284
0.5	81.94	15.0	6.991	40.0	-14.623
1.0	66.67	20.0	0.651	50.0	-19.54
1.5	57.73	20.6	0	—	—
2.0	51.39	21.0	-0.4238	—	—

7. SETTING OF CALIBRATION GAS CONCENTRATION





While setting zero/span calibration concentration, press the **ZERO** key once, then the number of the digit increases by one digit, and press the **SPAN** key, then the number of the digit decreases by one digit. Setting digit is moved to the right by one by pressing the **ENT** key. However, if the **ENT** is pressed while setting the 3rd digit, calibration concentration setting will be ended.

Note) Pressing the **ESC** key allows the setting to be canceled midway.

7.1 How to set span calibration gas concentration

Description

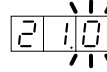
- Set span calibration gas concentration. Use air generally.
- For air, set 20.6% O₂.
- The settable range is from 10.0 to 29.9% O₂.

Order	Operation	How to set the span calibration gas concentration to 21.0% O ₂ . (It is generally set to 20.9% O ₂ before shipment).	
	Key operation	Description	Displayed message
①	SPAN + ESC	Press the SPAN key and ESC key simultaneously, then the lamp begins to blink (the number in the 1st digit blinks).	
②	ENT , ZERO	Press the ENT key to blink the 2nd digit. Press the ZERO key to change "0" to "1".	
③	ENT , ZERO	Press the ENT key to blink the 3rd digit. Press the ZERO key (increase) to change "9" to "0".	
④	ENT	Press the ENT key, then the display set to 21.0 returns to measurement display status.	 Measurement display
To cancel the setting, press the ESC key.			

7.2 How to set zero calibration gas concentration

Description

- Set zero calibration gas concentration. Set the value specified on the gas cylinder.
- For zero gas, Use O₂ gas of 1.01% or less.
- The settable range is from 0.00 to 99.9% O₂.

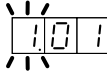
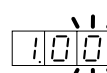
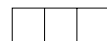
Order	Operation	How to set the zero calibration gas concentration to 1.00% O ₂ . (It is generally set to 1.01% O ₂ before shipment).	
	Key operation	Description	Displayed message
①	ZERO + ESC	Press the ZERO key and ESC key simultaneously, then the lamp begins to blink (the number in the 1st digit blinks).	
②	ENT , ENT , SPAN	Press the ENT key twice to blink 3rd digit. Press the SPAN key (decrease) to change "1" to "0".	
③	ENT	Press the ENT key, then the display that is set to 1.00 returns to measurement display status.	 Measurement display
To cancel the setting, press the ESC key.			

8. CALIBRATION

In order to maintain good accuracy, proper calibration using calibration gas is necessary.

Perform manual operation (Refer to 8.2).

8.1 Preparation

- Wiring/piping check

Wiring and piping work should be made correctly referring to Item. 4.3. The main plug of standard gas should be left open. Since high pressure is present at piping connections, use blind-nut type joints and take special care with regard to air-tightness. Calibration gas flow should be 1 to 1.5 ℓ /min.



- Setting of calibration gas concentration



Referring to Chapter 7 “Setting of calibration gas concentration”, set the oxygen concentration in standard gas cylinder to be used.

8.2 Manual calibration

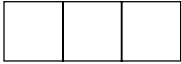
Caution before operation

- Span/zero is calibrated once.
- Calibration should be performed in the order of span and zero.
- For calibration, allow calibration gas to flow into the sensor. When the sensor output signal is stabilized, key operation is performed to complete the processing.

Order	Operation	Performing span calibration.	
	Key operation	Description	Displayed message
①		Open the stop valve to flow span gas.	 Measurement display
②	SPAN	Press SPAN , then the message at right appears. All of 3 digits blink.	 (All of 3 digits blink)
③	ENT	When display is stabilized, press ENT key and span calibration is completed.	 Measurement display
④		Close the stop valve.	
To cancel span calibration, press the ESC key.			

Order	Operation	Performing zero calibration.	
	Key operation	Description	Displayed message
①		Open the stop valve to flow zero gas.	 Measurement display
②	ZERO	Press ZERO , then the message at right appears. All of 3 digits blink.	 (All of 3 digits blink)
③	ENT	When display is stabilized, press ENT key and zero calibration is completed.	 Measurement display
④		Close the stop valve.	
To cancel span calibration, press the ESC key.			

9. RANGE SELECTION

- ① Open the door by removing 4 screws (M5).
- ② Remove 3 mounting screws (M3) fastening the operation panel. Remove the operation panel.
- ③ Set the range selection switch at the near of the operation panel at range position.

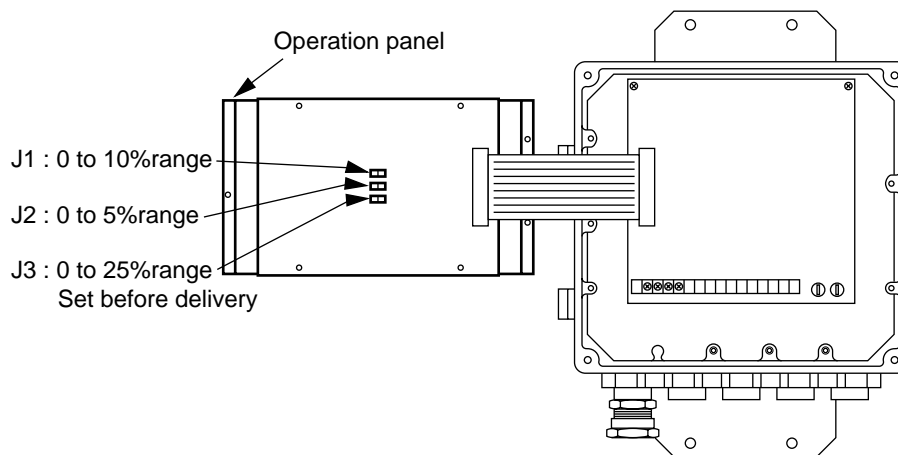

10. ADJUSTMENT

10.1 Zirconia input signal adjustment

Description

- This is used to adjust zero/span input of zirconia sensor signal.
- This adjustment should be made when required accuracy cannot be obtained after calibration.
In general, do not perform the above operation because it is based on the factory adjustment mode.

(1) How to adjust zero input

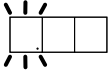
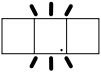
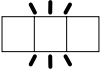
Order	Operation (example)	How to adjust zero input	
	Key operation	Description	Displayed message
①		Apply a voltage of $0\pm 0.01\text{mV}$ to external terminals of 3(+) and 4(-).	
②	ENT + ESC	Hold down the ENT key and ESC key simultaneously for more than 5 seconds, then the decimal point in the 1st digit begins to blink.	
③	ENT	Press the ENT key, then the decimal point in the 2nd digit begins to blink.	
④	ZERO	Press the ZERO key to blink the number in the 2nd digit.	
⑤	ENT	After confirming that voltage is applied to the terminals, press the ENT key, and then zero input adjustment can be performed.	
To cancel adjustment, press the ESC key.			

(2) How to adjust span input

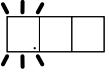
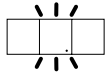
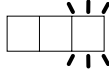

Order	Operation (example)	How to adjust span input	
	Key operation	Description	Displayed message
①		Apply a voltage of $50\pm 0.01\text{mV}$ to external terminals of 3(+) and 4(-).	
②	ENT + ESC	Hold down the ENT key and ESC key simultaneously for more than 5 seconds, then the decimal point in the 1st digit begins to blink.	
③	ENT	Press the ENT key, then the decimal point in the 2nd digit begins to blink.	
④	SPAN	Press the SPAN key to blink the number in the 3rd digit.	
⑤	ENT	After confirming that voltage is applied to the terminals, press the ENT key, and then span input adjustment can be performed.	
To cancel adjustment, press the ESC key.			

10.2 Temperature input adjustment

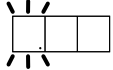

Description

- This is used to adjust zero/span adjustment of the thermocouple.
In general, do not perform the above operation because it is based on the factory adjustment mode.

(1) How to perform zero adjustment of thermocouple input

Order	Operation (example)	How to perform zero adjustment of thermocouple input	
	Key operation	Description	Displayed message
①		Apply a voltage confirming to 700°C to external terminals, 1(+) and 2(-).	
②	ENT + ESC	Hold down the ENT key and ESC key simultaneously for more than 5 seconds, then the decimal point in the 1st digit begins to blink.	
③	ZERO	Press the ZERO key, 2nd digit blinks in 700 display.	
④	ENT	After confirming that voltage is applied to the terminals, press the ENT key, and then zero adjustment can be performed.	
To cancel adjustment, press the ESC key.			

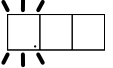
(2) How to perform span adjustment of thermocouple input

Order	Operation (example)	How to perform span adjustment of thermocouple input	
	Key operation	Description	Displayed message
①		Apply a voltage confirming to 800°C to external terminals, 1(+) and 2(-).	
②	ENT + ESC	Hold down the ENT key and ESC key simultaneously for more than 5 seconds, then the decimal point in the 1st digit begins to blink.	
③	SPAN	Press the SPAN key, 3rd digit blinks in 800 display.	
④	ENT	After confirming that voltage is applied to the terminals, press the ENT key, and then span adjustment can be performed.	
To cancel adjustment, press the ESC key.			

10.3 Current output adjustment

Description

- This adjustment should be made when required accuracy can not be obtained after calibration. This is adjusted prior to delivery, so no further adjustment is required for normal operation.
- Adjust current by connecting an ammeter and a load resistor of 250Ω to external terminals 5(+) and 6(-).

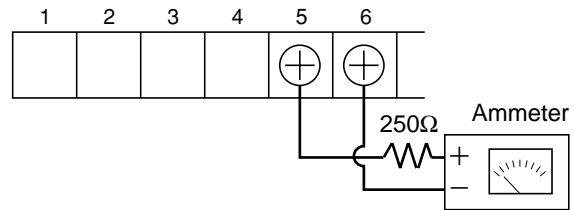

Order	Operation (example)	How to perform zero adjustment of current output	
	Key operation	Description	Displayed message
①	ENT	Hold down the ENT key for more than 5 seconds, then the decimal point in the 3rd digit begins to blink.	
②	ZERO + ESC	Press the ZERO key and ESC key simultaneously, and zero adjustment mode (000 display) is displayed.	
③	SPAN or SPAN + ESC	Press the SPAN key (increase) or press SPAN key + ESC key simultaneously (decrease) so that the ammeter may read 4mA.	
④	ENT	When the ammeter reads $4\pm 0.05\text{mA}$, press the ENT key. Zero adjustment is performed.	
To cancel zero adjustment, press the ESC key.			

Order	Operation (example)	How to perform span adjustment of current output	
	Key operation	Description	Displayed message
①	ENT	Hold down the ENT key for more than 5 seconds, then the decimal point in the 3rd digit begins to blink.	
②	SPAN + ESC	Press the SPAN key and ESC key simultaneously, and span adjustment mode (100 display) is displayed.	
③	ZERO or ZERO + ESC	Press the ZERO key (increase) or press ZERO key + ESC key simultaneously (decrease) so that the ammeter may read 20mA.	
④	ENT	When the ammeter reads $20\pm 0.05\text{mA}$, press the ENT key. Span adjustment is performed.	
To cancel span adjustment, press the ESC key.			

10.4 Setting of detector control temperature

Description

- Setting of control temperature is required according to types of the detector to be connected.





Type of detector and control temperature

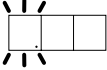

ZFK2 (general use type) Set to 800°C

ZFK5 (corrosion-proof type) ... Set to 750°C

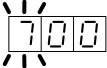
In general, do not perform the above operation because it is based on the factory adjustment mode.

When the detector needs to be replaced with another type, it becomes necessary to change the set value.

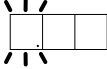
Order	Operation (example)	Setting to 750°C (ZFK5)	
	Key operation	Description	Displayed message
①	ENT + ESC	Press the ENT key and ESC key at the same time for more than 5 seconds, and the decimal point in the 1st digit begins to blink.	
②	ZERO	When the ZERO key is pressed, the detector is set in the temperature control mode with the figure 700 displayed and the 2nd digit begins to blink.	
③	SPAN	Next, press the SPAN key. The figure "7" in the 1st digit begins to blink.	
④	ZERO	Then, press the ZERO key. The figure "7" blinking in the 1st digit disappears and the 2nd digit begins to blink.	
⑤	ENT (or ESC)	Press the ENT key (or ESC key), and the control temperature is set to 750°C when the display returns to the measurement mode.	 Measurement display
To cancel the above operation, press the ESC key.			
* Do not press the ESC key under the condition of ②.			

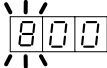
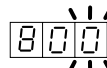
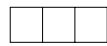
Order	Operation (example)	Setting to 800°C (ZFK2)	
	Key operation	Description	Displayed message
①	ENT + ESC	Press the ENT key and ESC key at the same time for more than 5 seconds, and the decimal point in the 1st digit begins to blink.	
②	SPAN	When the SPAN key is pressed, the detector is set in the temperature control mode with the figure 800 displayed and the 2nd digit begins to blink.	
③	ZERO	Next, press the ZERO key. The figure "8" in the 1st digit begins to blink.	
④	SPAN	Then, press the SPAN key. The figure "8" blinking in the 1st digit disappears and the 3rd digit begins to blink.	
⑤	ENT (or ESC)	Press the ENT key (or ESC key), and the control temperature is set to 800°C when the display returns to the measurement mode.	 Measurement display
To cancel the above operation, press the ESC key.			
* Do not press the ESC key under the condition of ②.			

10.5 Selection of alarm contact output

Description

- Select the converter alarm contact output.
- Select the contact output from the 5th digit of the converter code symbols.



The 5th digit of code symbol:

B.... Normal Open contact is selected.

C.... Normal Close contact is selected.

For details of alarm contact output, refer to Item 6.4 Check on alarm data (Page 8).

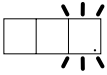
In general, do not perform the above operation because it is based on the factory adjustment mode.

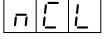
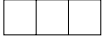
Order	Operation (example)		Selection of alarm contact output	
	Key operation	Description	Displayed message	
①	ENT	When the ENT key is pressed for more than 5 seconds, the decimal point in the 3rd digit begins to blink.		
②	ENT + ESC	Press the ENT key and ESC key at the same time to display the setting of the present contact output. n 0 P Normal Open contact n C L Normal Close contact	 Normal Open contact	
③	ZERO	By pressing the ZERO key, n 0 P and n C L are selected alternately.	 Normal Close contact	
④	ENT	By pressing the ENT key, the setting is finished when the display returns to the measurement mode.	 Measurement display	
To cancel the above operation, press the ESC key.				

11. MAINTENANCE AND CHECK

11.1 Check

In order to keep the instrumentation operating in good condition, perform the following periodical maintenance and check.

Perform maintenance and check once every year or 2, or at time of furnace check.

	Check items	Measures
Daily check	Zero, span calibration	Calibrate once every week (Refer to Chapter 8 “Calibration”)
	Deterioration of packings and O-rings	If deteriorated, replace with new ones.
	Check for loose cable ground	Retighten or replace the packing.
	Check the remain pressure in the calibration gas cylinder	Check the amount using primary pressure.
Periodical check	Clogging or corrosion of flow guide tubes	Remove the flow guide tube from the furnace wall, remove the detector and wash the flow guide tube with water.
	Clogging or corrosion of ejector type sampling prove	Remove the ejector from the furnace wall, disassemble the prove and wash it with water.
	Clogging of air outlet of ejectors	Remove the ejector from the furnace wall and clean the air outlet located in the heat insulation layer of the furnace wall.

11.2 Fuse replacement

When a fuse blows, turn off the power switch, and replace the fuse after investigating the cause.

Open the front cover of the sensor. Two fuses are located at lower right. The right fuse is for protection of the sensor circuit and the left one is for protection of the heater.

Take care that these fuses are different each other in the rated current.

For replacement, use a vessel style (flat-blade) screwdriver or coin.

Push down the cap on the fuse holder and rotate about 1/4 turn counterclockwise until the cap is removed from the fuse holder.

Then, replace the fuse with a new one.

Next, push in the cap and rotate about 1/4 turn clockwise until it is fitted to the fuse holder.

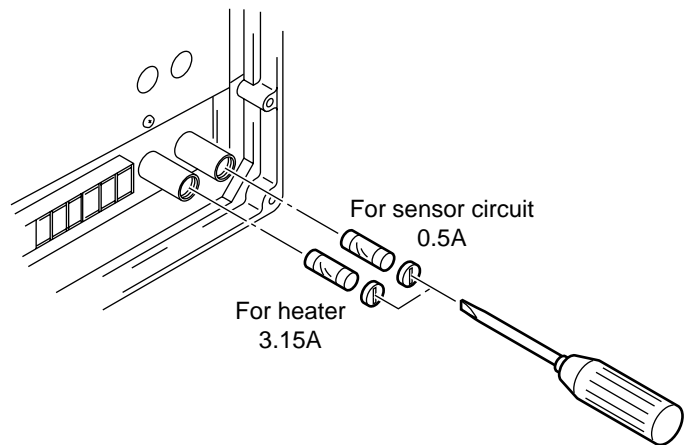

Fuse unit specifications (Reference)

	Specification
For circuit	ø5.2 × 20mm 0.5A JIS C 6575 MF51 250V 0.5A
For heater	ø5.2 × 20mm 3A JIS C 6575 MF51 250V 3.15A

11.3 Troubleshooting

Symptoms	Probable causes	Checking methods	Remedy
No display	Converter fuse blown out	Check the fuse and supply voltage specification.	Replace fuse Check power supply voltage
Indication does not change or slow response	Filter and/or flow guide tube clogged	Visual check of filter and flow guide tube for contamination or clogging. Check for loosen and gas leaks at piping connections and mounting place of detector.	Clean or replace filter Tighten pipe connections
	Sensor element deterioration	Change over between zero and span gas and check if 5 minutes or longer is needed for 90% response.	Replace sensor element
	Decrease in flow velocity of exhaust gas	Check response to process gas after shutting down calibration gas. Move the direction (mounting position) of "arrow" of the flow guide slightly.	Increase process gas flow into the flow guide tube
Indication too high or too low	Loose flange and its surroundings	Check for gas leaks in detector and mounting part of flow guide tube flange.	Tighten mounting screws Replace O-ring
	Deteriorated O-rings	Check for leaks from the outside.	Seal
	Senor malfunction	Check for gas leaks at calibration gas inlet. Check sensor element voltage (mV) for higher or lower than other sensor when flowing zero gas	Tighten connectors Replace sensor element
	Break of wiring	Ohmic check of wiring	Replace
	Wrong wiring	Wiring check	Correct wiring
	Lower power supply voltage	Check of supply voltage specification	Check supply voltage
	Break of thermocouples	Ohmic check	Replace sensor element
	Blown heater fuse	Ohmic check of fuse	Replace fuse
	Break in sensor heater	Check heater resistance 50 to 55Ω for 115V, 200 to 250Ω for 220V (Excluding wiring resistance)	Replace sensor element
Indication difference between dry and wet base measurement	Oxygen concentration is higher in dry base.	Normal	

12. APPENDIX

12.1 Specification

(1) General

- Measured gas : Oxygen contained in non-combustible gas
- Measuring method : Direct inserting type zirconia system
- Measuring range : 0 to 5%, 1 to 10% and 1 to 25% (selected by setting pin)
- Oxygen concentration output signal : 4 to 20mA DC (allowable load resistance 500Ω max.)
Input-output isolation, linear characteristic versus oxygen concentration
- Alarm contact output :
 - Contact specifications; 1 point, 1a, 250V AC, 2A
 - Contact function; Fault (error)Alarm contact Close/Open is as specified.
- Self-diagnosis function : Detector temperature error, zero calibration error, span calibration error
- Repeatability : ±1% FS
- Linearity : ±2% FS
- Response speed : Within 7 sec for 90% response (from calibration gas inlet)
- Power supply : 100/115, 200/220 or 230V AC 50/60Hz
- Power consumption : 15VA + 50VA in normal operation
15VA + 200VA at startup
- Warmup-time : 15 minutes approx.
- Cable : Maximum length between sensor and converter 100m (To be ordered separately)

(2) Oxygen detector (type ZFK2, 5)

- Measuring instrument : General use ZFK2
For corrosive gas ZFK5
- Measured gas temperature : -20 to 600°C for flow guide tube type (for general use, corrosive gas)
- Measured gas pressure : -3 to +3kPa {-300 to +300mmH₂O}
- Flow guide tube : Without blow-down nozzle
Flange : JIS-5K 65A FF
Insertion length (according to specification) : 0.3, 0.5, 0.75, 1.0m
- Ambient temperature : -20 to 60°C (for cable section)
125°C or less at the sensor flange surface with power ON
- Structure : Dust/rain-proof structure (IEC standard IP55)
- Filter : Alumina (filtration accuracy 50μ) and quartz paper
- Material of gas-contacting parts : General use detector : Zirconia, SUS316, SUS304, platinum
For corrosive gas detector : Zirconia, titanium, platinum, SUS316 (flow guide tube)
- Detector mounting : Horizontal ±45°, surrounding air should be clean.
- Outline dimensions : (L × max. dia.) 210 × 100mm (sensor)
- Mass : Sensor, approx. 1.6kg
Flow guide tube of 1m (general use type), approx. 5kg
- Finish color : Silver and SUS metallic color

(3) Oxygen converter (type ZRY)

- Display : 3-digit LED
- Calibration method : Manual calibration with calibration key
- Calibration gas :
 - Setting range for zero gas; 0.01 to 9.99% O₂
span gas; 10.0 to 29.9% O₂
 - Recommended concentration of calibration gas :
zero gas; 0.25 to 2.0% O₂
span gas; 20.6 to 21.0% O₂ (air)
- Structure : Dust/rain-proof structure (IEC standard IP65)
Use a block cap of G1/2 for useless wiring port.
To prevent water leak, use cable gland for other wiring ports.
to prevent water leak.
- Mounting method : Mounting on panel surface
- Finish color : Munsell 6PB35/10.5, Silver
- Outline dimensions (H × W × D) : 230 × 220 × 95mm
- Mass : Approx. 4.5kg
- Ambient temperature : -10 to 50°C
- Ambient humidity : 90%RH or less
- Power source : 90 to 230V AC 50/60Hz

12.2 Designation of type (PILC code table)

(1) Type of converter

1 2 3 4 5 6 7 8 9 10 11 12												Description					
Z	R	Y	1					1	1	1	0	1	R	E	0	Alarm contact output, measurement output "Close" at alarm, 4 to 20mA DC	
												B				"Open" at alarm, 4 to 20mA DC	
												C				Option	
												Y				Without selector cock	
												D				With selector cock	
																Thermocouple specification	
												R				Thermocouple R	
																Specification	
																0	Standard

(2) Type of detector

1 2 3 4 5 6 7 8 9 10 11 12 13 14 Digits														Description	
Z	F	K		R		4	-							Application	
														General use	
														For corrosive gas (refuse incinerator)	
														Calibration gas inlet	
														1	Polypropylene joint for ø6 tube
														2	Brass joint for ø1/4 in. tube
															Power supply
														1	100/115V AC 50/60Hz
														3	200/220V AC 50/60Hz
														5	230V AC 50/60Hz (CE-marking approved)
															Flow guide tube
															Flange material
														0 Y 0	None
														5 A 3	SUS304
														5 A 5	SUS304
														5 A 7	SUS304
														5 A 1	SUS304
														5 B 3	SUS316
														5 B 5	SUS316
														5 B 7	SUS316
														5 B 1	SUS316
														Z Z Z	Others
															NOTE) As for the flange dimension, JIS 5K-65A FF is standard.
															Protection cover
														Y	Without
														A	With
															Reference air inlet
														Y	None
														A	Rc 1/8
														B	NPT 1/8
															None-standard spec.
														Z	Other none-standard items

(3) Type of exclusive cable connecting converter to sensor

1	2	3	4	5	6	7	8	9 Digit	Description
Z	R	Z					1		Specification For ZRY
			P						Type For thermocouple R
				Y	A				Flexible conduit length Without Cable length 6m
				Y	B				Without 10m
				Y	C				Without 15m
				Y	D				Without 20m
				Y	E				Without 30m
				Y	F				Without 40m
				Y	G				Without 50m
				Y	H				Without 60m
				Y	J				Without 70m
				Y	K				Without 80m
				Y	L				Without 90m
				Y	M				Without 100m
				A	A				6m 6m
				B	B				10m 10m
				C	C				15m 15m
				D	D				20m 20m
									Max. flexible conduit length 20m Max. cable length 100m
								0	Termination Without
								1	One end (sensor ZFK side)
								2	Both ends

(4) Type of replacement sensor

1	2	3	4	5	6	7	8	9	10	11	12	13	Digits	Description
Z	F	K	R				4	0	Y	0	Y	Y		Application General use For corrosive gas (refer to incinerator)
				2										Calibration gas inlet
					1									Polyproprene joint for ø6 tube
					2									Brass joint for ø1/4 in. tube
														Power supply
					1									100/115V AC 50/60Hz
					3									200/220V AC 50/60Hz
					5									230V AC 50/60Hz (CE-marking approved)

12.3 Outline diagram (unit:mm)

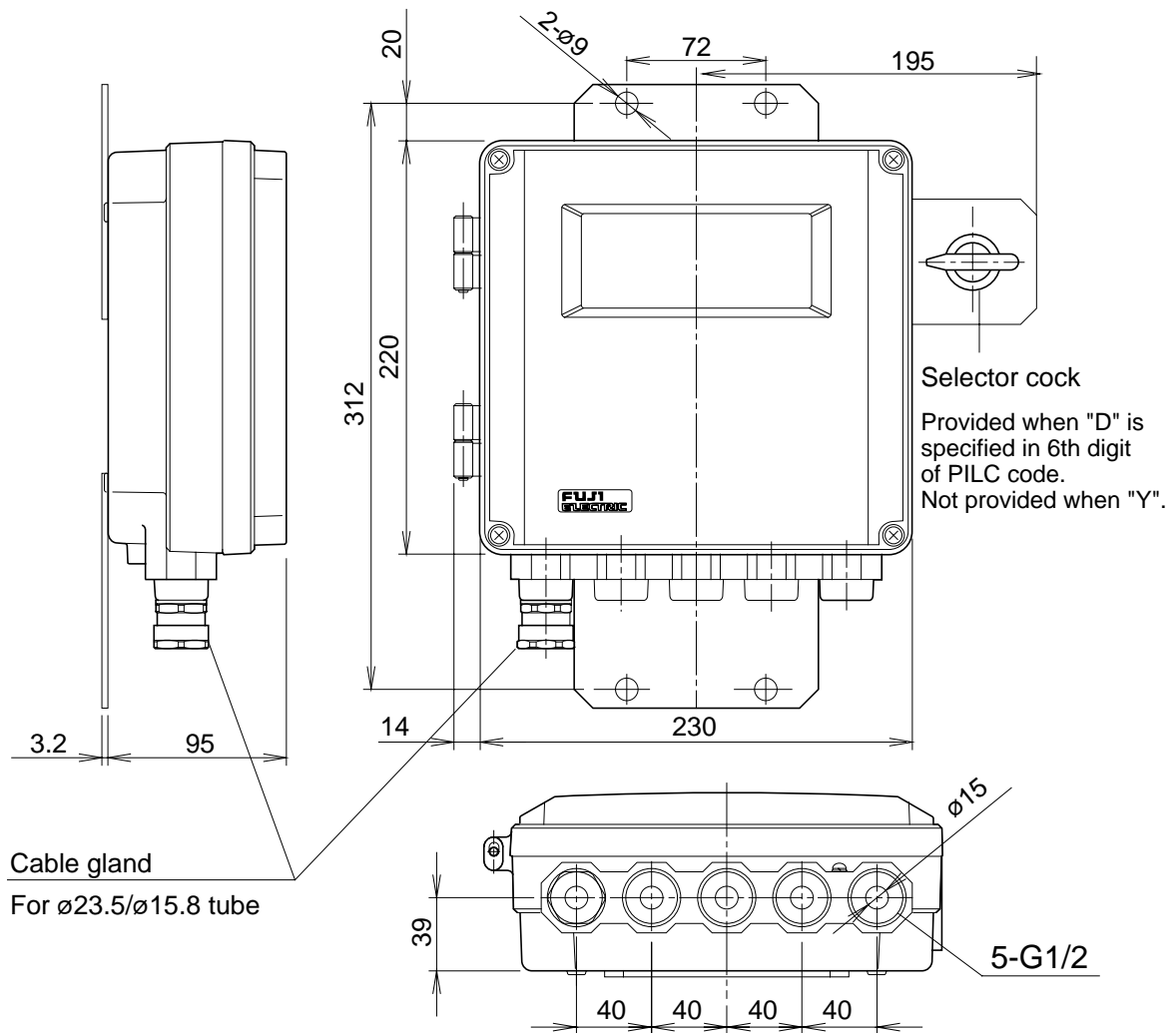

Connection diagram

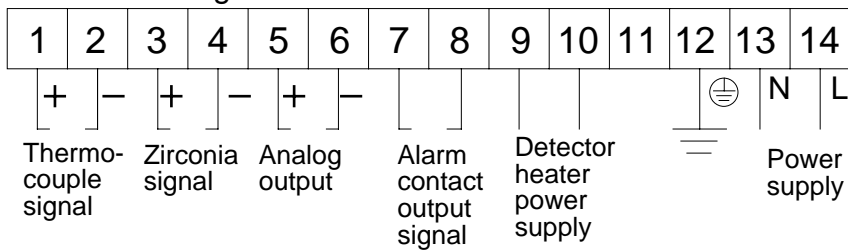

Conditions of converter alarm contact output
(between No.7 and No.8 terminals)

The 5th digit of converter code symbols	Power OFF	Power ON, normal	Power ON, alarm
B	Open	Open	Closed
C	Open	Closed	Open