

Wire Colors # Duty

2	Black	1 Heater
	White	2 Heater
	Red	3 TC+
4	White	4 TC-
	Yellow	5 O2-
	Blue	6 O2+

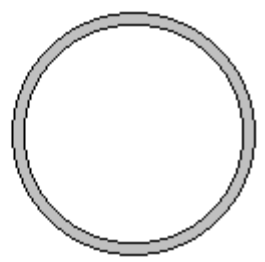
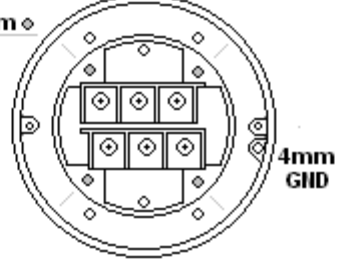
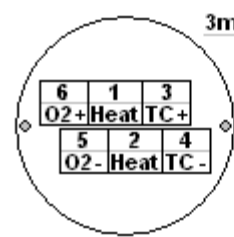

DELTA INSTRUMENT LLC Northvale, NJ 07647.	
Job:	Rev: 2
ZFK8 - Oxygen Detector	
ZFK-R-005	Date: 03/01/10

Terminal Cover

Terminal Block

P36 O'Ring Seal

Plug Open Port
If 1/4" Cal Tube
Is Not Connected

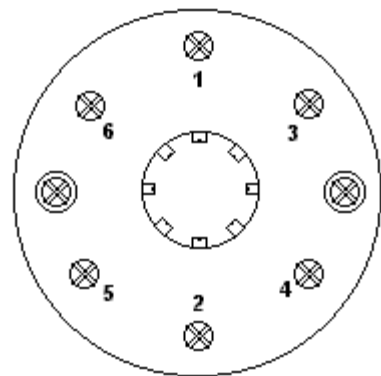

Terminal Block

Wiring Chart:

- 1 - Black } Heater
- 2 - White } Heater
- 3 - Red + } T/C "R"
- 4 - White - } T/C "R"
- 5 - Yellow - } Signal
- 6 - Blue + } Signal

WARNING:
Do Not Rotate Body
Relative To Flange

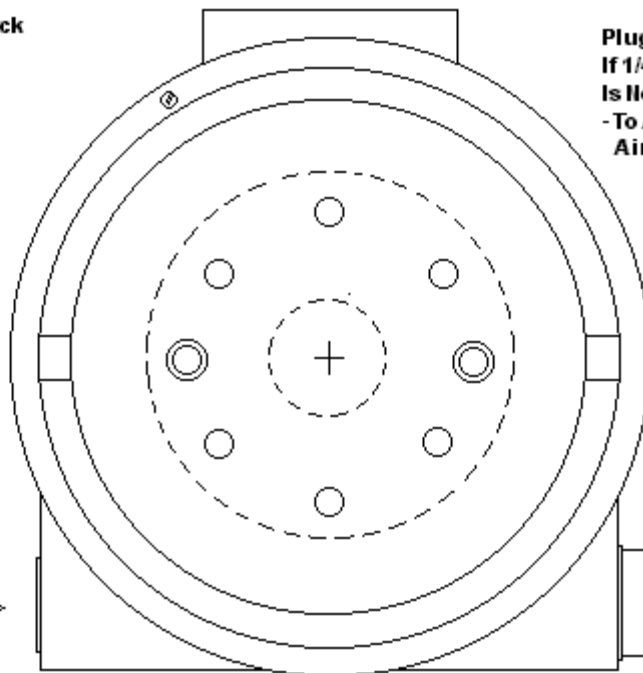

Connecting Cable
Entry - 3/4" NPT →

Replacable Twist-lock
Sample Gas Filter

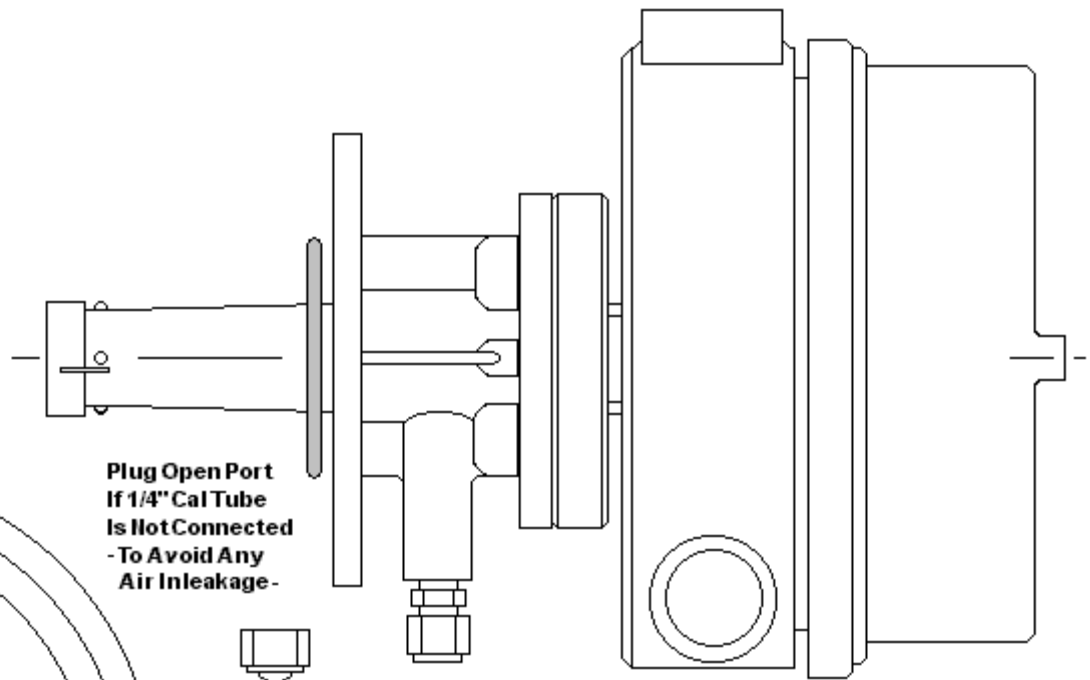

Plug Open Port
If 1/4" Cal Tube
Is Not Connected
- To Avoid Any
Air Inleakage -

Calibration Gas
1/4" Tube

Reference Air Entry
Flame Arrester Exit
With Weather Neck

Warranty Will Be Void If Body
Is Rotated Relative To Flange

DELTA INSTRUMENT LLC
Northvale, NJ 07647.

Job:	Rev: 0
ZFK8 -Exp. Oxygen Detector for Hazardous Areas C1D1 Gp. B, C & D	
ZFK-8E-005 - 00	Date: 2/1/2012

Flange Size: 4" 150# RF
 Bolt Circle: 7.5" Dia
 Flange Dia: 9"

6 x 5mm x 14 mm
 Hex Cap Screws

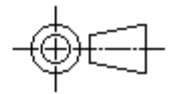

Probe Lengths in Inches:
 L = 12, 20, 30, 40, 60, 80, 100, 120, 140

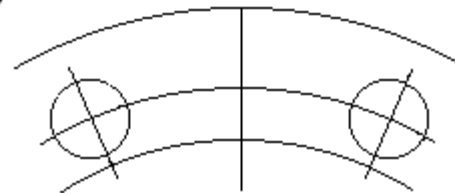

Bolt Pattern

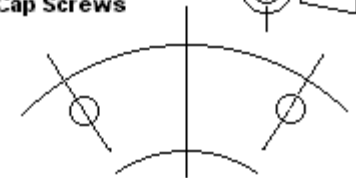

Bolt Pattern

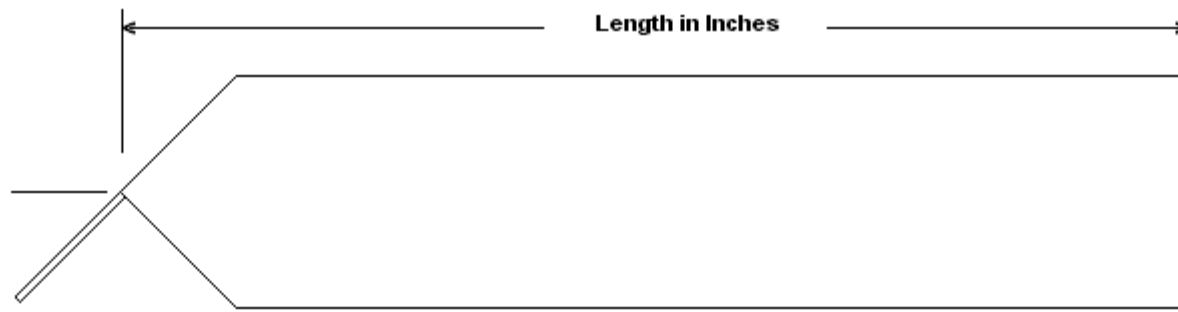

Side View

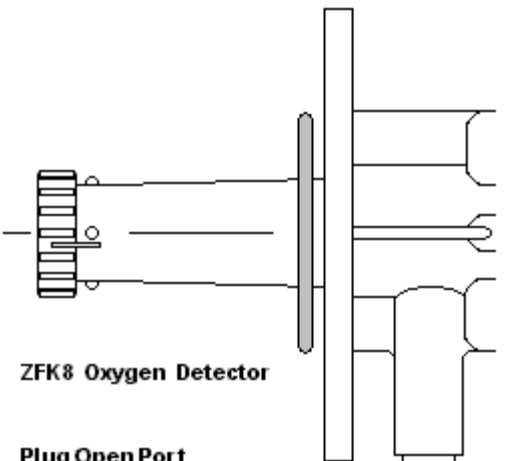
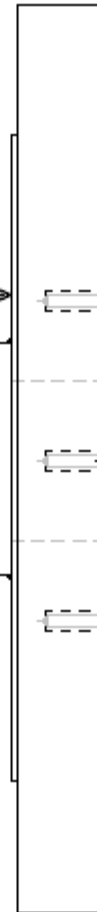

ZFK8 Oxygen Detector

Plug Open Port
 If 1/4" Cal Tube
 Is Not Connected
 - To Avoid Any
 Air Inleakage -

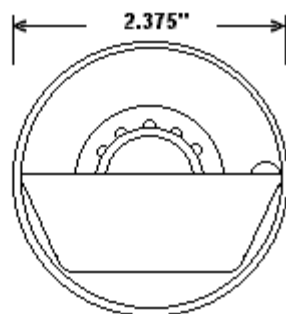

End View

Example Part Number:
 12" Long = ZFK-P-012

Materials of Construction: 304 SS

DELTA INSTRUMENT LLC Northvale, NJ 07647.	
Job:	Rev: 2
ZFK - Probe	
ZFK-P-XXX - 00	Date: 08/01/09

Flange Size: 4" 150# RF
 Bolt Circle: 7.5" Dia
 Flange Dia: 9"

Blow Down Air Port
 1/2" NPT

6 x 5mm x 14 mm
 Hex Cap Screws

Probe Lengths in Inches:
 L = 12, 20, 30, 40, 60, 80, 100, 120, 140

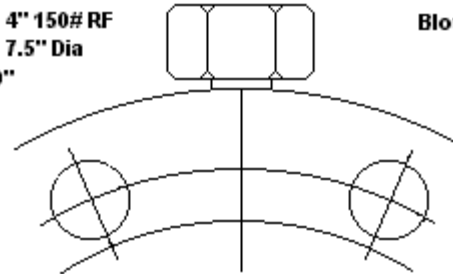

Bolt Pattern

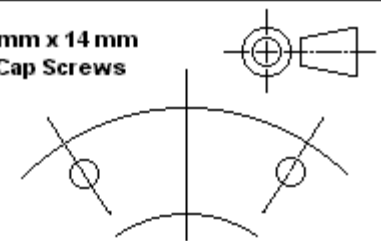

Bolt Pattern

Length in Inches

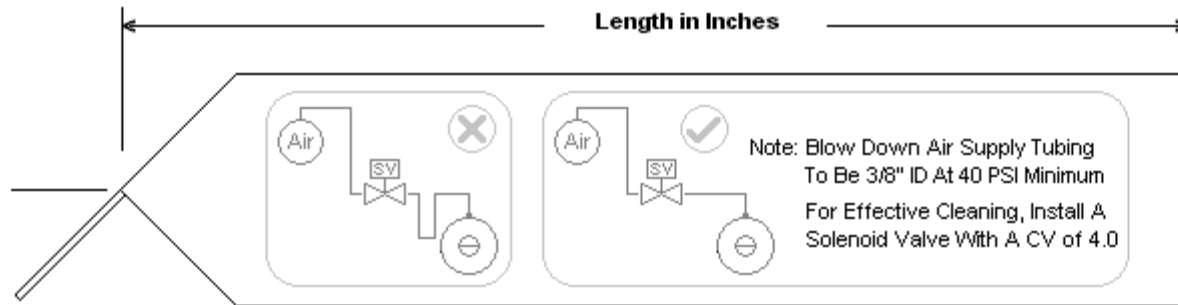

Side View

Note: Blow Down Air Supply Tubing
 To Be 3/8" ID At 40 PSI Minimum
 For Effective Cleaning, Install A
 Solenoid Valve With A CV of 4.0

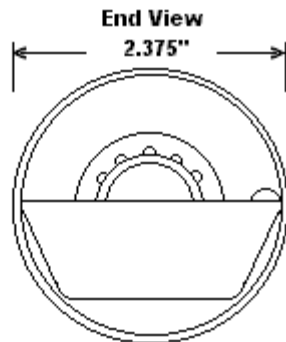

End View

2.375"

Example Part Number:
 12" Long = ZTB-P-012

Note: Corrosive Flue Gases?
 To Avoid Cold End Corrosion
 Adjust ZKM Blow Down Time
 From 30 to 6 sec's To Reduce
 'Air Cooling' Below Acid D/P
 Due To Extended B/D Times

ZFK8 Oxygen Detector

Plug Open Port
 If 1/4" Cal Tube
 Is Not Connected
 - To Avoid Any
 Air Inleakage -

All Dimensions in mm

Materials of Construction: 304 SS

DELTA INSTRUMENT LLC
 Northvale, NJ 07647.

Job:	Rev: 3
ZTB - Probe With Blow Down	
ZTB-P-XXX - 00	Date: 08/01/09

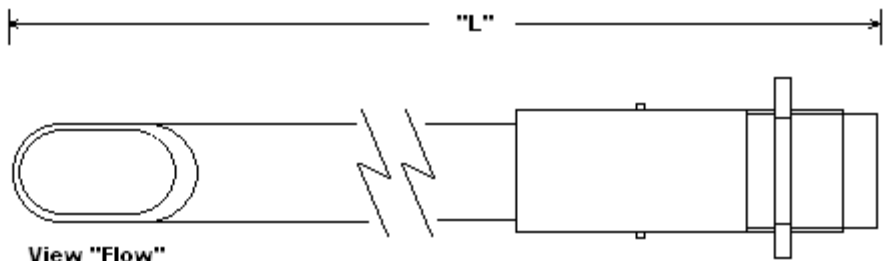

View "Flow"

Note:
Use O2 Sensor Safe
Thread Anti Seize.

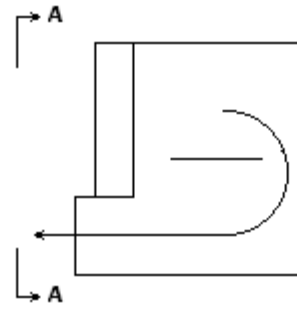
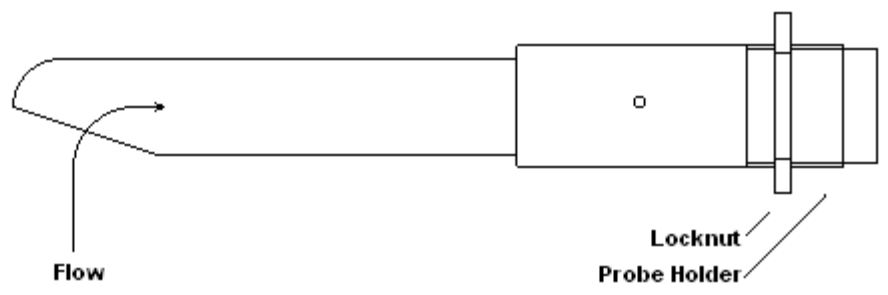

60.3

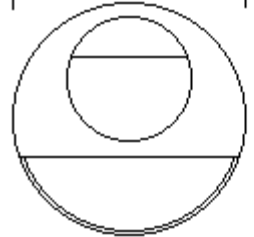

View "A-A"

Probe Tube: 26 OD x 19mm ID
Probe Holder: 33mm OD

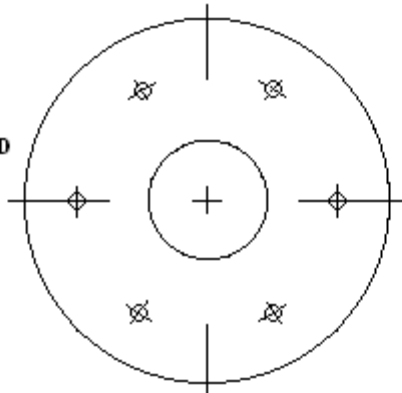

Bolt Pattern

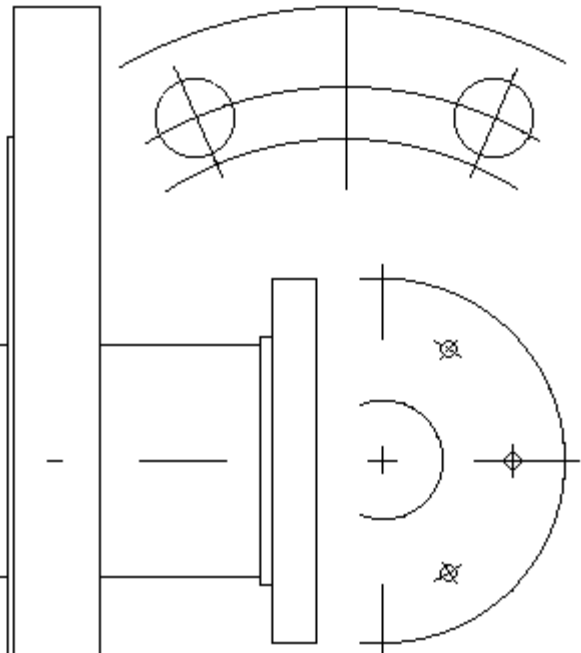
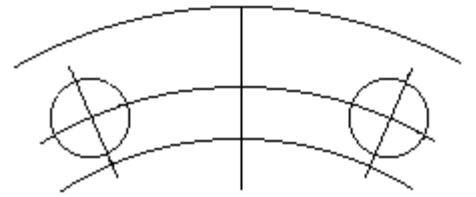

Flange - 8 Bolt
4" 150lb RF S/S

DELTA INSTRUMENT LLC Northvale, NJ 07647.	
Job:	Rev: 2
ZFK-ST Probe Arrangement	
Drawing# ZFK-ST-XXX	Date: 08/01/09

All Dimensions in mm

For Effective Cleaning, Install A Solenoid Valve With A CV of 4.0

Note: Blow Down Air Supply Tubing To Be 3/8" ID At 40 PSI Minimum

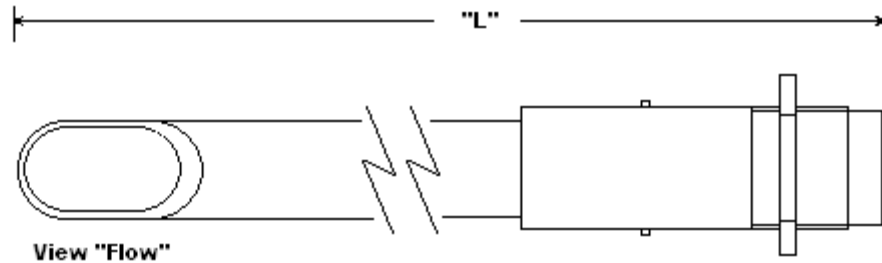
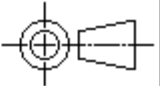

View "Flow"

Note:
Use O2 Sensor Safe
Thread Anti Seize.

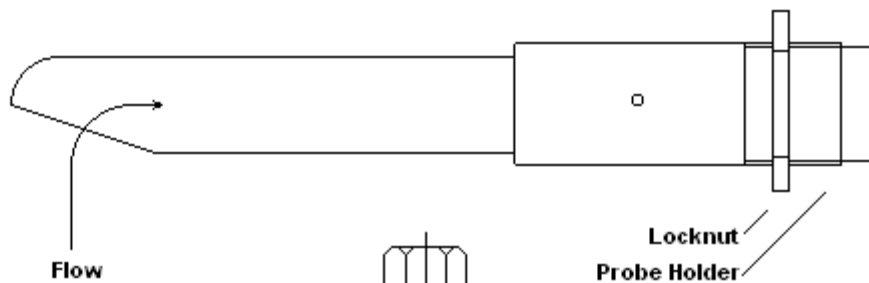

Locknut
Probe Holder

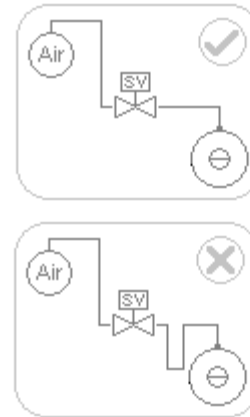

Probe Tube: 26 OD x 19mm ID
Probe Holder: 33mm OD

Note: Corrosive Flue Gases?
To Avoid Cold End Corrosion
Adjust ZKM Blow Down Time
From 30 to 6 sec's To Reduce
'Air Cooling' Below Acid D/P
Due To Extended B/D Times

All Dimensions in mm

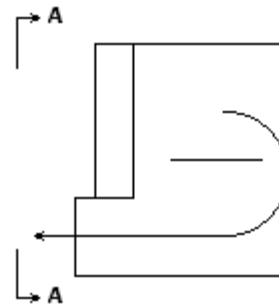
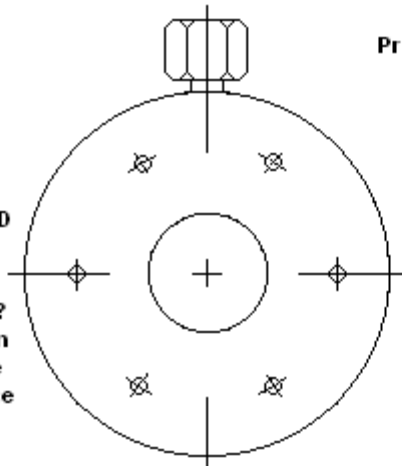

60.3

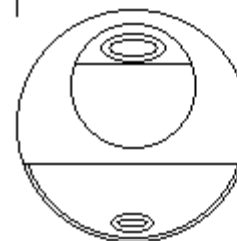

View "A-A"

Bolt Pattern

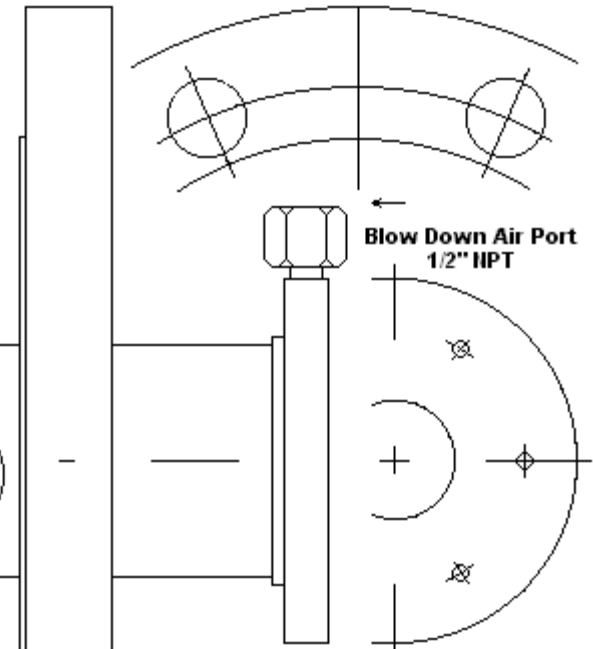

Blow Down Air Port
1/2" NPT

Flange Size: 4" 150# RF
Bolt Circle: 7.5" Dia
Flange Dia: 9"

DELTA INSTRUMENT LLC Northvale, NJ 07647.	
Job:	Rev: 3
ZTB-ST Probe Arrangement	
Drawing# ZTB-ST-XXX	Date: 08/01/09

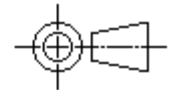

190

210

Probe Lengths:
ZTA-P-020
ZTA-P-030
ZTA-P-040
ZTA-P-060

"L"

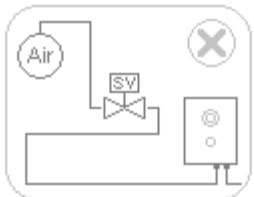

Note: Blow Down Air Supply Tubing
To Be 3/8" ID At 40 PSI Minimum
For Effective Cleaning, Install A
Solenoid Valve With CV of 4.0

Note: Corrosive Flue Gases?
To Avoid Cold End Corrosion
Adjust ZKM Blow Down Time
From 30 to 6 sec's To Reduce
'Air Cooling' Below Acid D/P
Due To Extended B/D Times

Flange Size: 3" 150# RF
Bolt Circle: 6" Diameter



Threaded Probe
End: 1 1/4" IPT

Wetted Parts: Ceramic and 304 SS

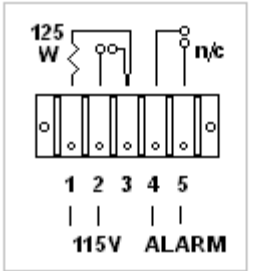
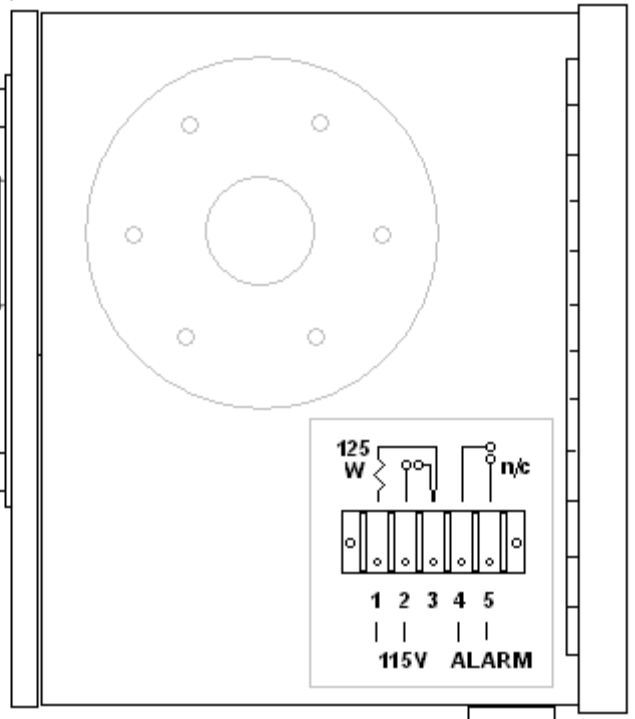

Box Size: 210 x 190 x 161

Materials of Construction: 304 SS

DELTA INSTRUMENT LLC Northvale, NJ 07647.	
Job:	Rev: 1
ZTA Probe Mounting Box	
ZTA-A-010	Date: 01/31/08

Flange Size: 3" 150# RF
 Bolt Circle: 6" Dia
 Flange Dia: 7.5"

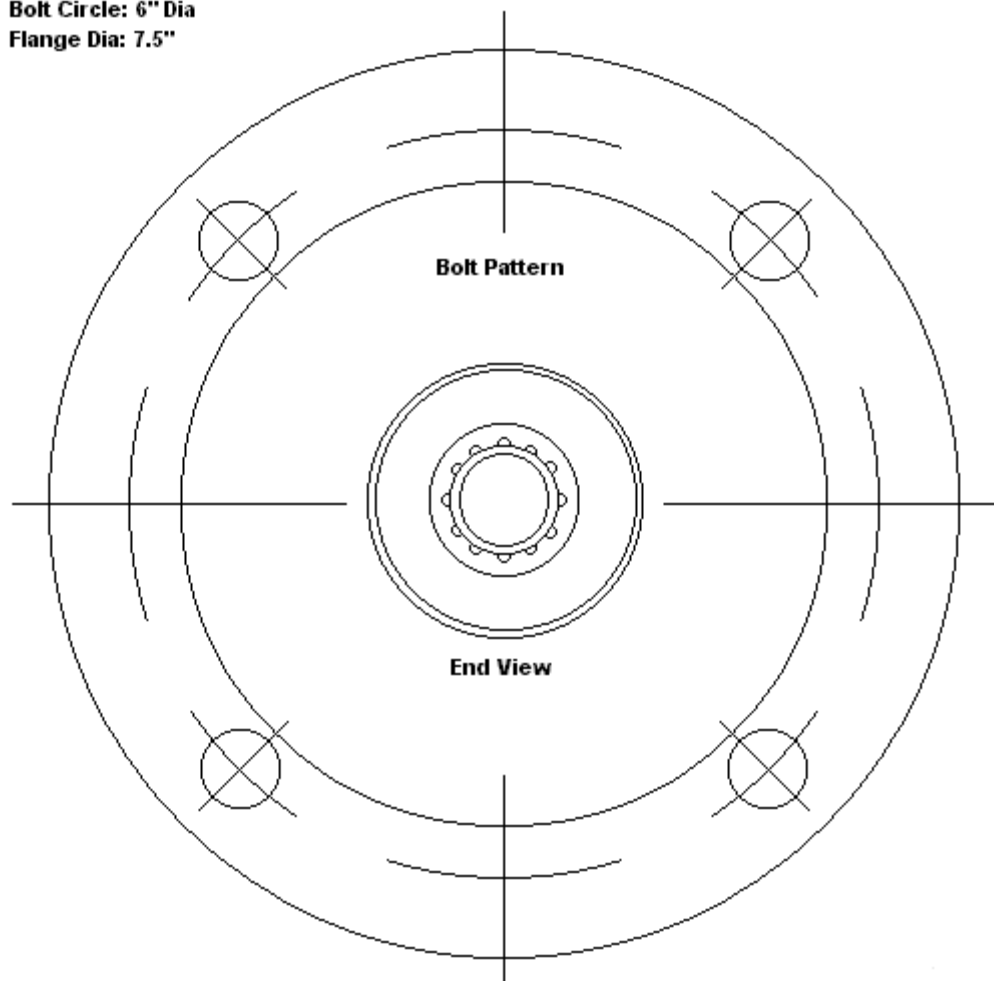

Hole Schedule: 1 x 1 3/8"
 4 x 3/4"
 6 x 5mm

Materials of Construction: 304 SS

6 x 5mm x 14 mm
 Hex Cap Screws

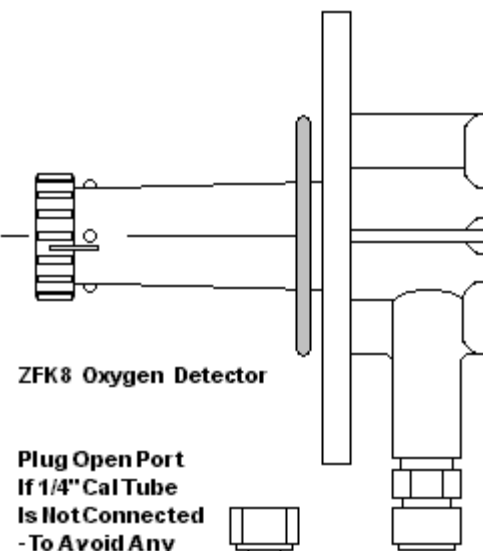
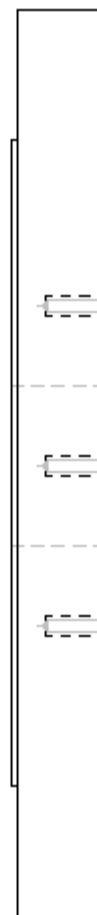
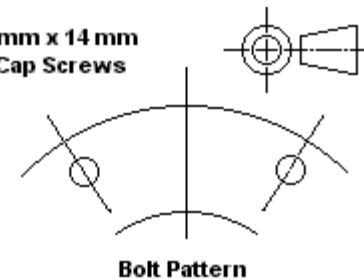

DELTA INSTRUMENT LLC Northvale, NJ 07647.	
Job:	Rev: 1
ZFK - 3" Mounting Flange	
ZFK-DS-003 - 00	Date: 08/01/12

Flange Size: 3" 150# RF
 Bolt Circle: 6" Dia
 Flange Dia: 7.5"

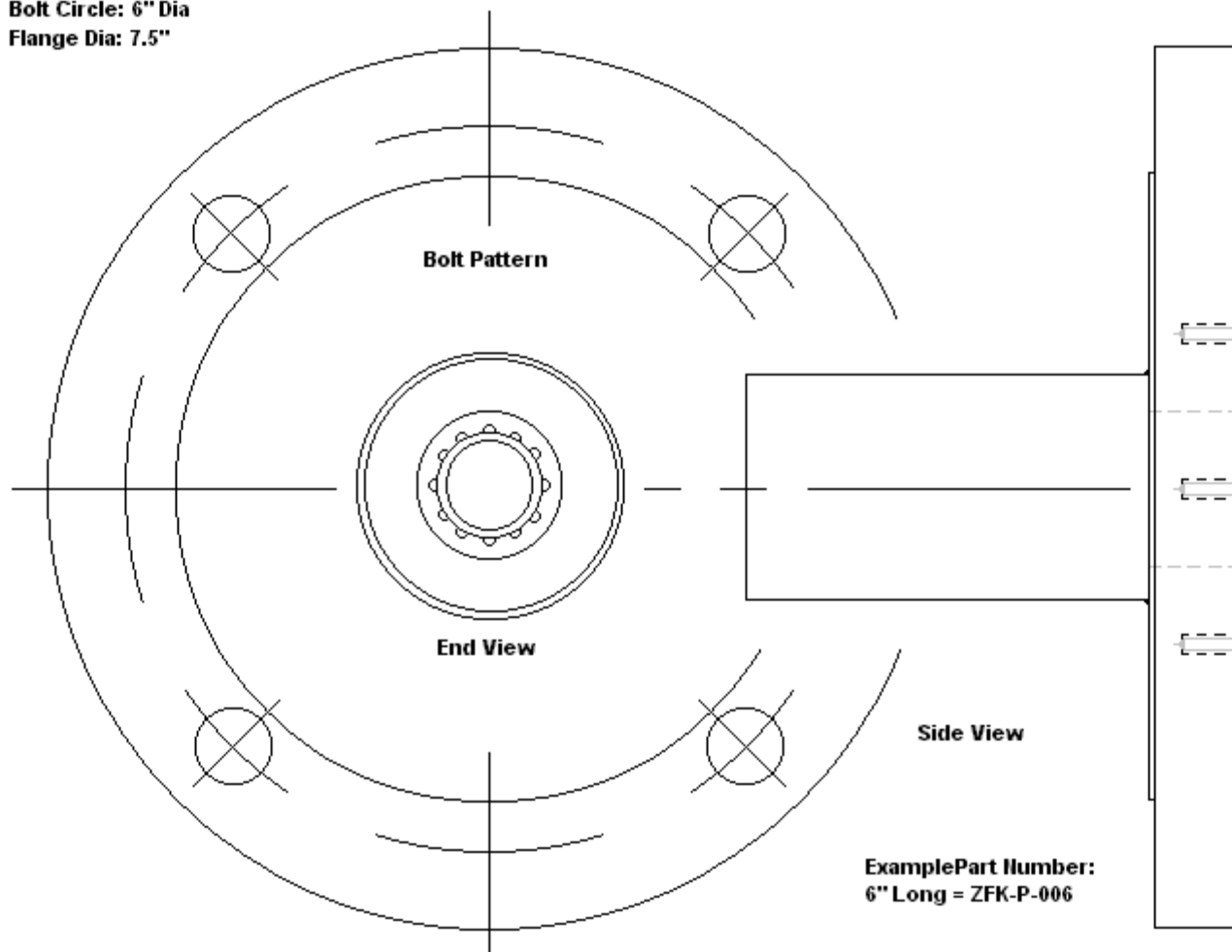

6 x 5mm x 14 mm
 Hex Cap Screws

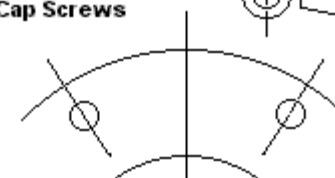
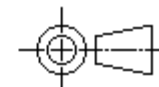

Bolt Pattern

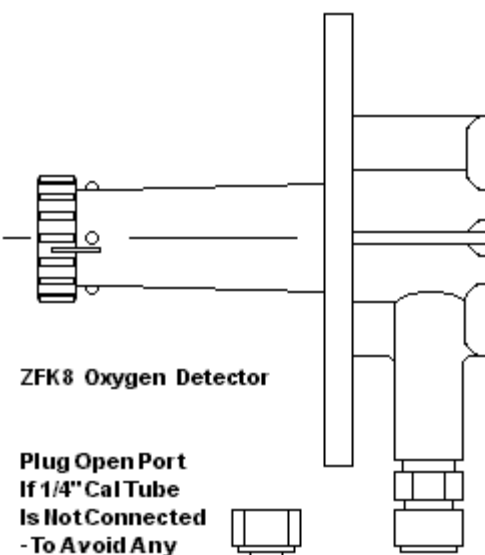

ZFK8 Oxygen Detector

Plug Open Port
 If 1/4" Cal Tube
 Is Not Connected
 - To Avoid Any
 Air Inleakage -



Example Part Number:
 6" Long = ZFK-P-006

Hole Schedule: 1 x 1 3/8"
 4 x 3/4"
 6 x 5mm

Materials of Construction: 304 SS

DELTA INSTRUMENT LLC Northvale, NJ 07647.	
Job:	Rev: 0
ZFK Probe - Special 3" Inch Flange	
ZFK-P-006 - 00	Date: 08/01/12

Flange Size: 4" 150# RF
 Bolt Circle: 7.5" Dia
 Flange Dia: 9"

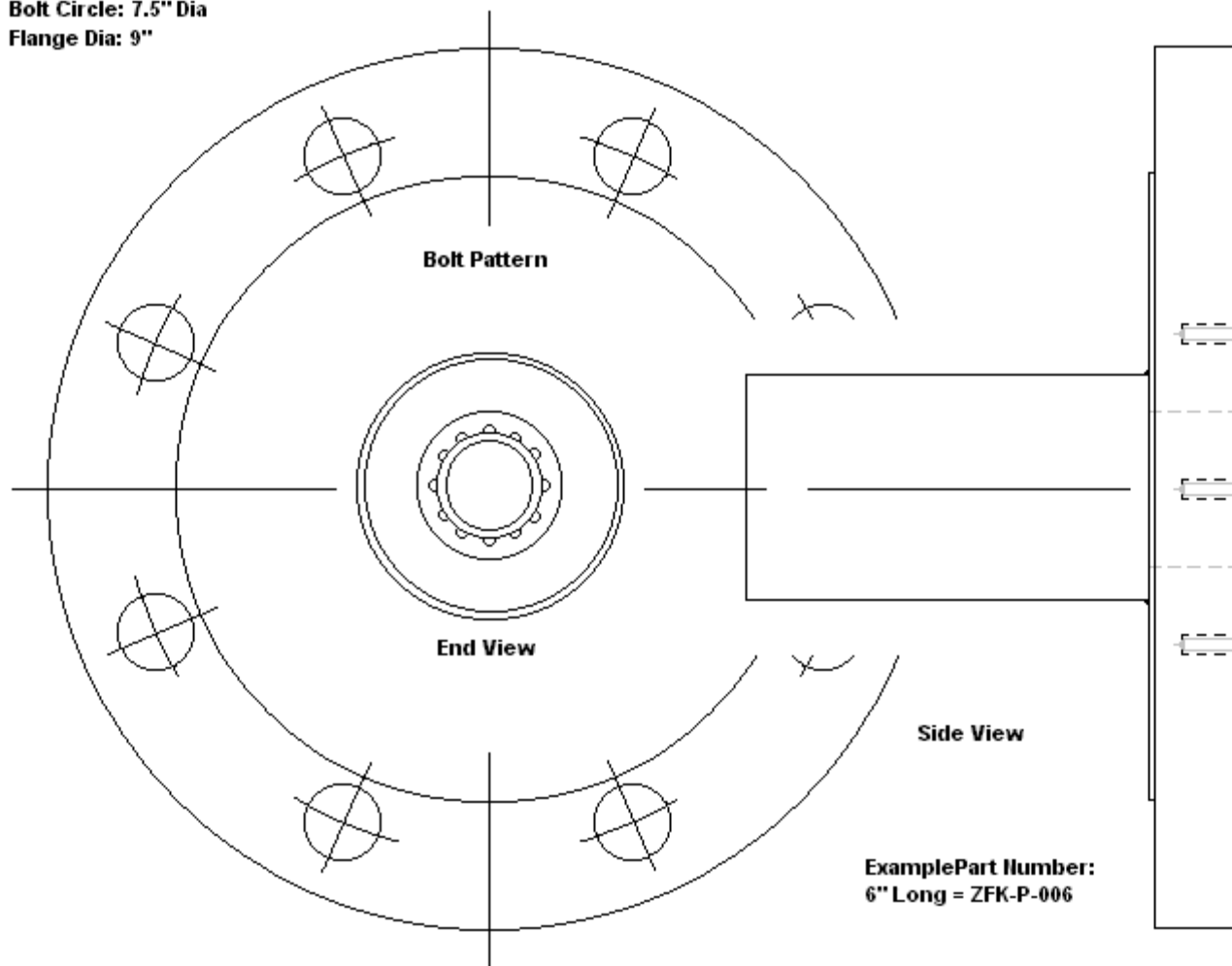

6 x 5mm x 14 mm
 Hex Cap Screws

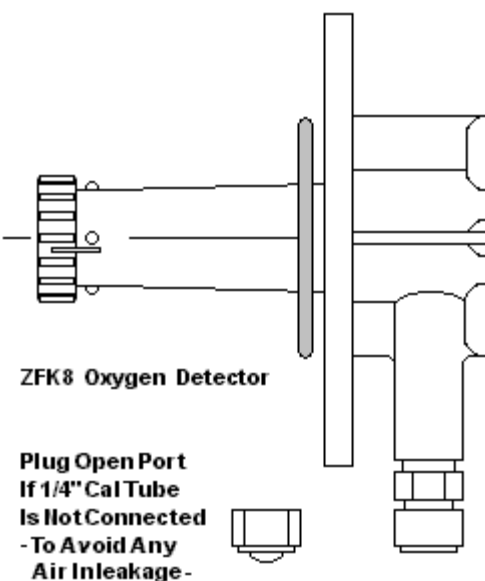
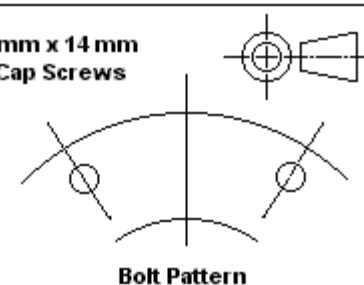

Hole Schedule: 1 x 1 3/8"
 4 x 3/4"
 6 x 5mm

Materials of Construction: 304 SS

Example Part Number:
 6" Long = ZFK-P-006

DELTA INSTRUMENT LLC Northvale, NJ 07647.	
Job:	Rev: 0
ZFK Probe - Special 4" Inch Flange	
ZFK-P-006 - 00	Date: 08/01/12

Flange Size: 4" 150# RF
 Bolt Circle: 7.5" Dia
 Flange Dia: 9"

Blow Down Air Port
 1/2" IPT

6 x 5mm x 14 mm
 Hex Cap Screws

Probe Lengths in Inches:
 L = 12, 20, 30, 40, 60, 80, 100, 120, 140

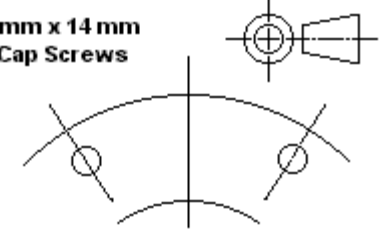
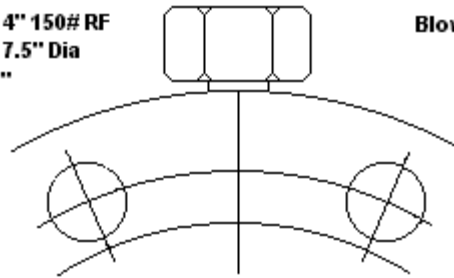

Bolt Pattern

Bolt Pattern

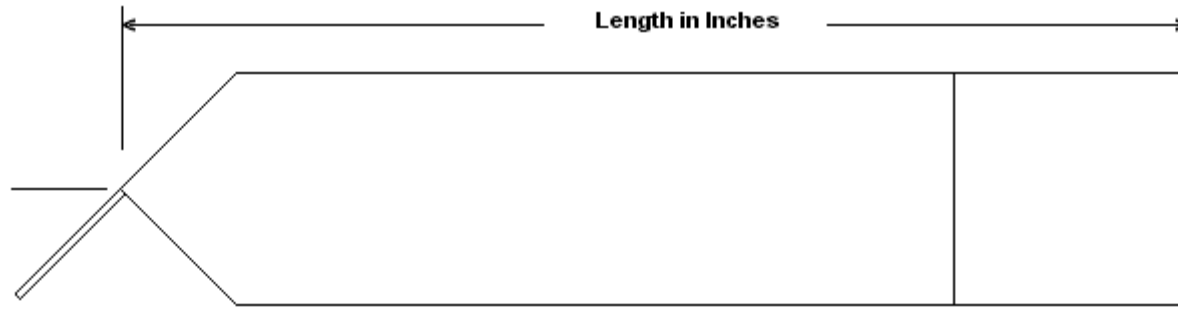

Length in Inches

Side View

C276 6"

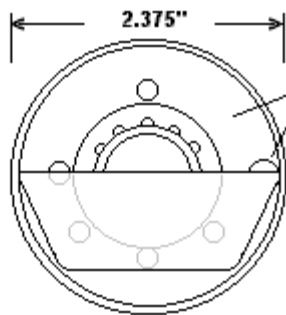

End View

C276
 Plug &
 Air Tube

Example Part Number:
 12" Long = ZTB-P-012

Note: Corrosive Flue Gases?
 To Avoid Cold End Corrosion
 Adjust ZKM Blow Down Time
 From 30 to 6 sec's To Reduce
 'Air Cooling' Below Acid D/P
 During Extended Blow Downs

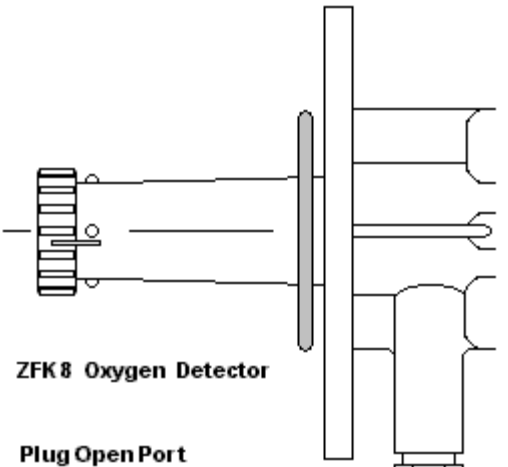

ZFK 8 Oxygen Detector

Plug Open Port
 If 1/4" Cal Tube
 Is Not Connected
 - To Avoid Any
 Air Inleakage -

Materials of Construction: 304 SS + C276

DELTA INSTRUMENT LLC Northvale, NJ 07647.	
Job:	Rev: 0
ZTB - Probe With Blow Down Incinerator Version	
ZTB-PI-XXX - 00	Date: 02/22/18

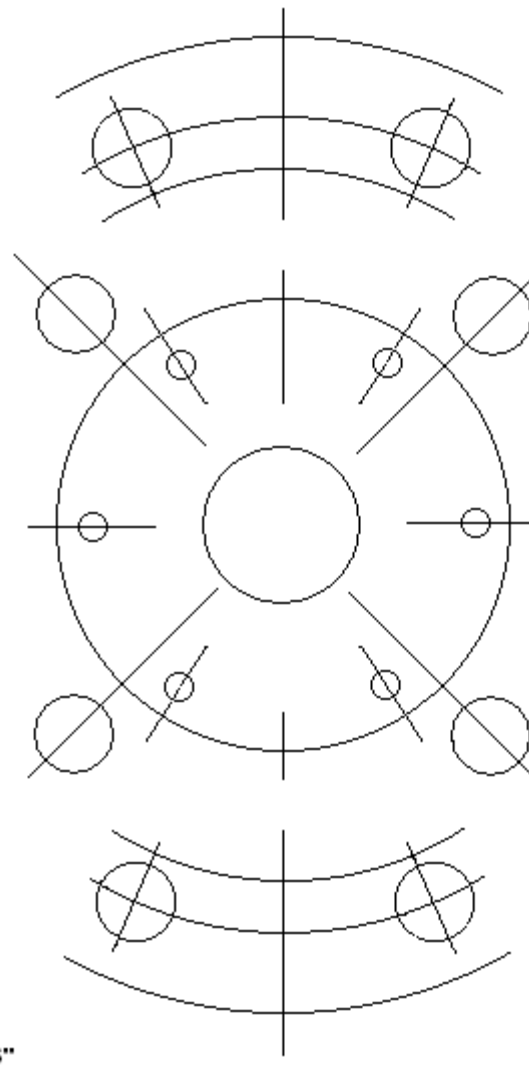
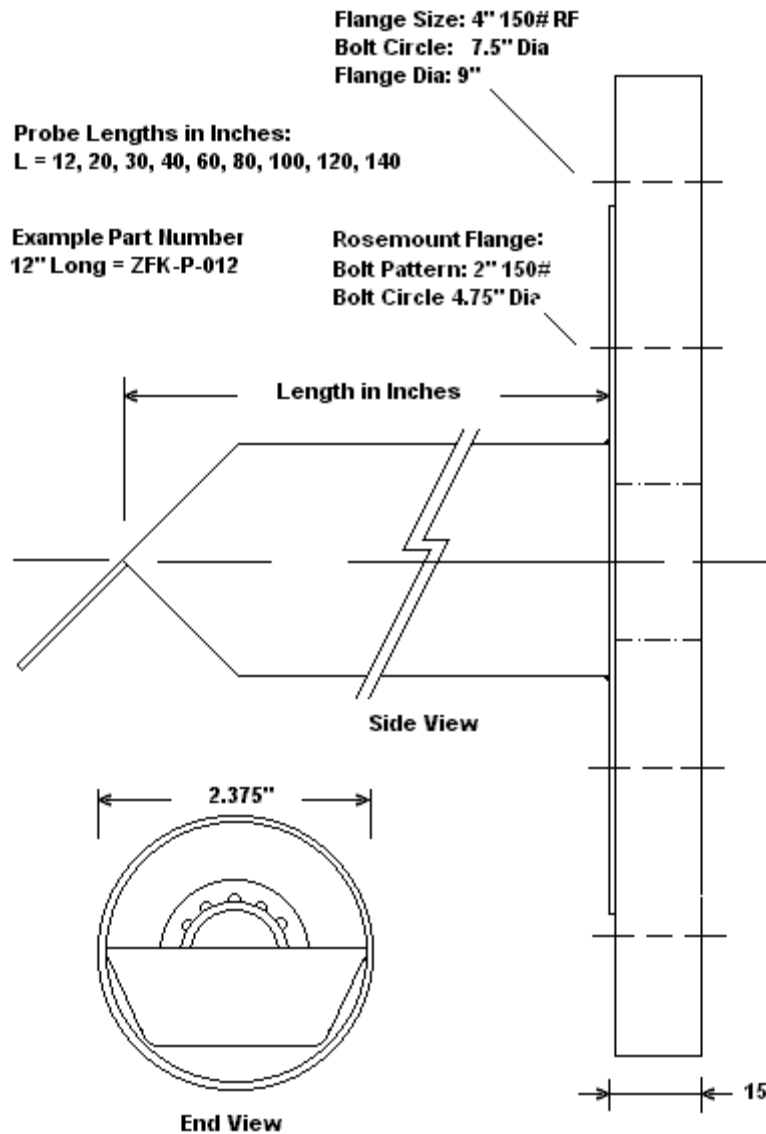

6 x 5mm x 14 mm
 Hex Cap Screws

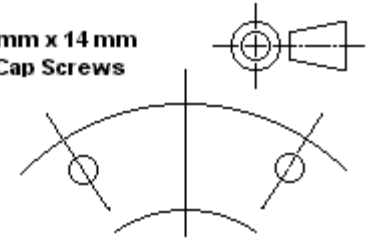

ZFK 8 Bolt Pattern

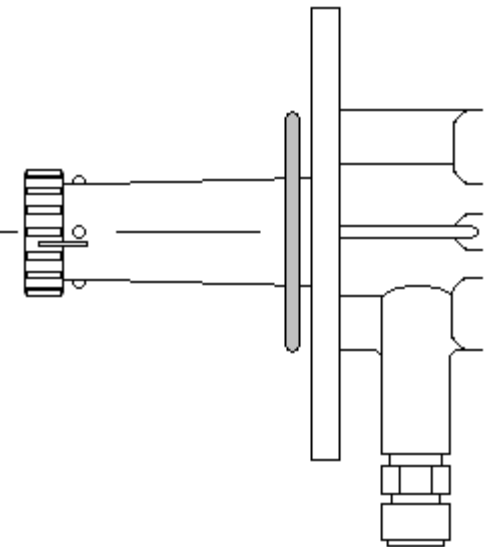

ZFK 8 Oxygen Detector

Materials of Construction: 304 SS

DELTA INSTRUMENT LLC Northvale, NJ 07647.	
Job:	Rev: 1
ZFK - Probe with 2" / 4" Bolt Pattern	
ZFK - P-XXX - 00	Date: 5/30/07

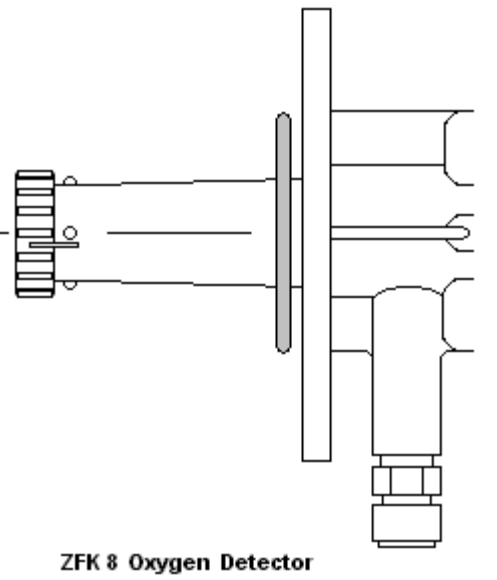
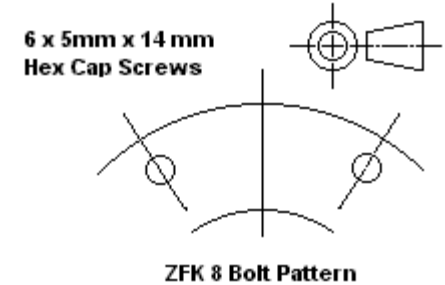
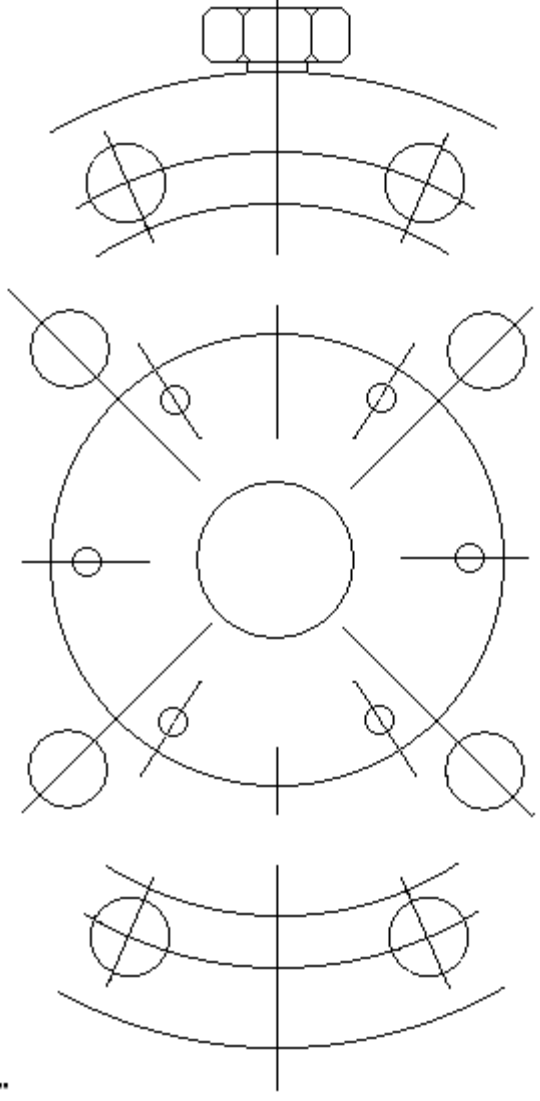
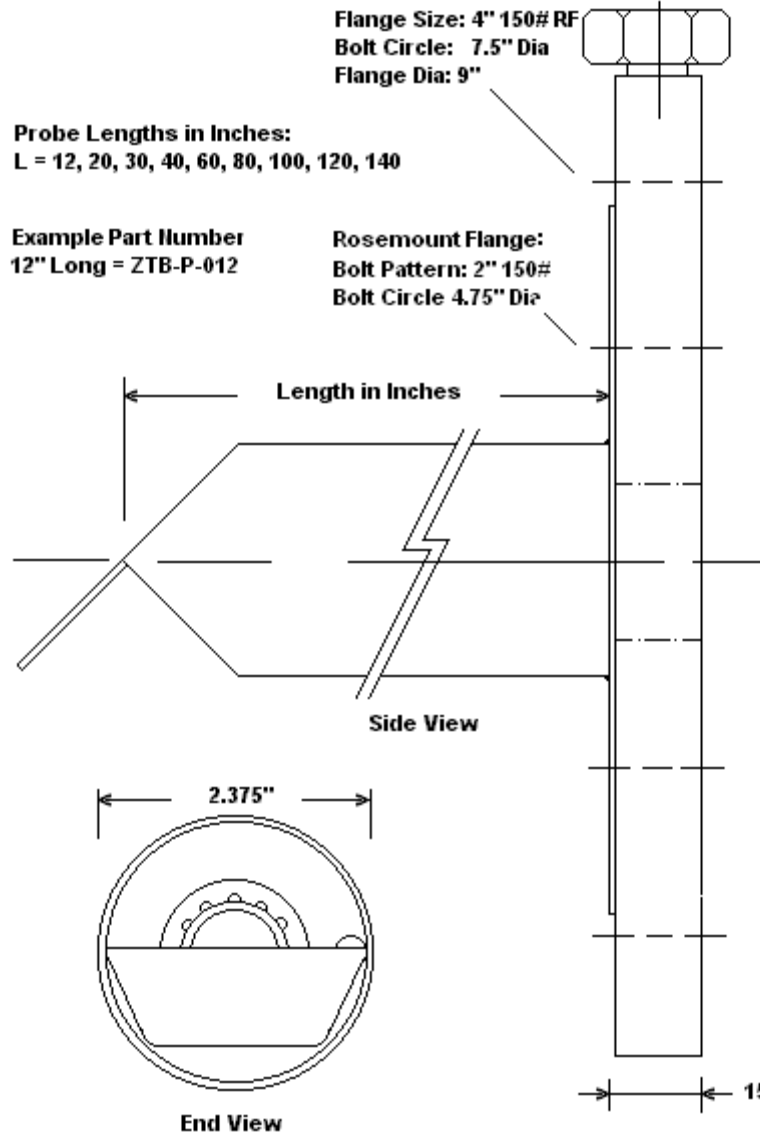

Materials of Construction: 304 SS

DELTA INSTRUMENT LLC Northvale, NJ 07647.	
Job:	Rev: 1
ZTB - Probe with 2" / 4" Bolt Pattern	
ZTB-P-XXX - 00	Date: 5/30/07

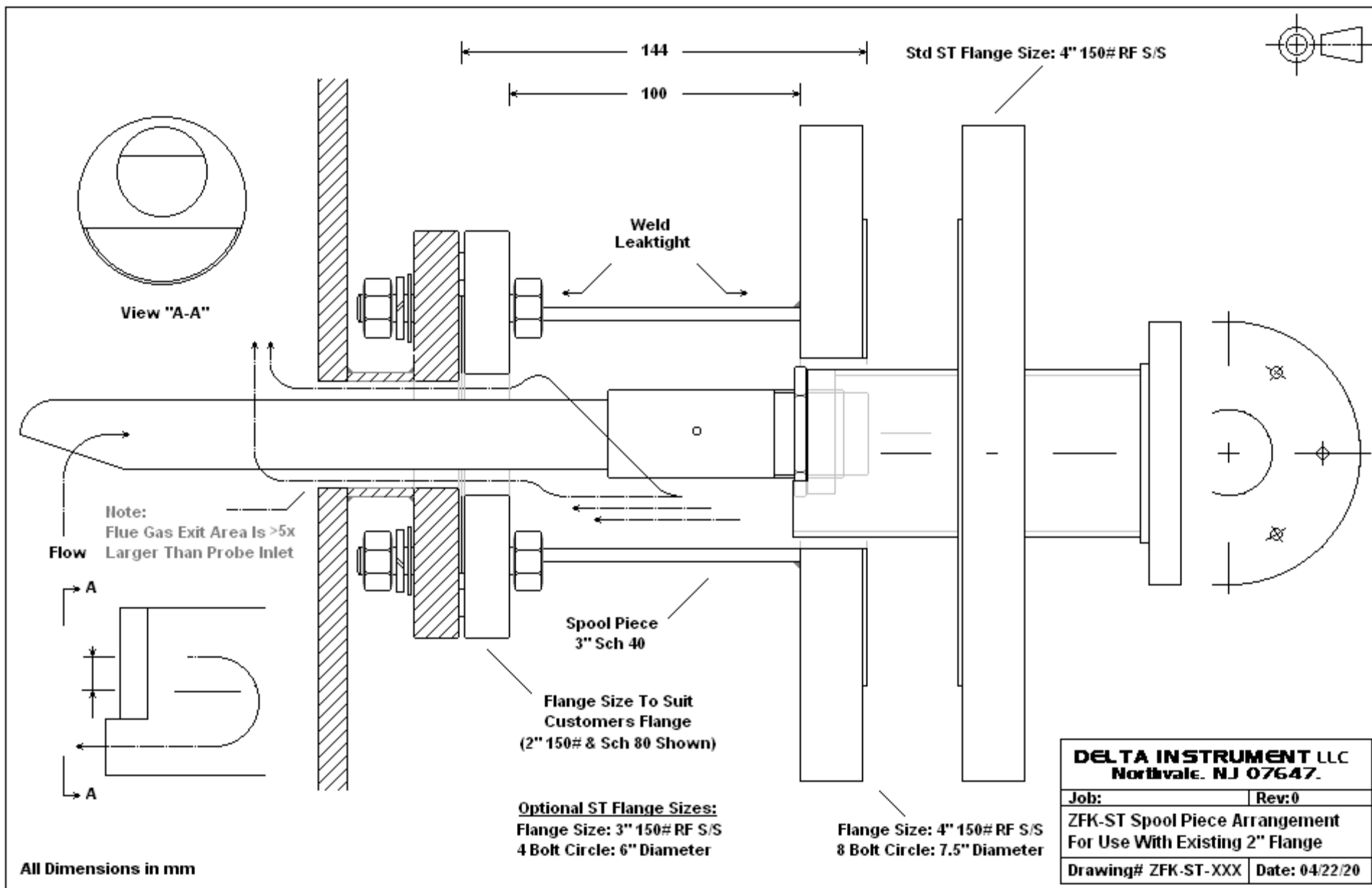

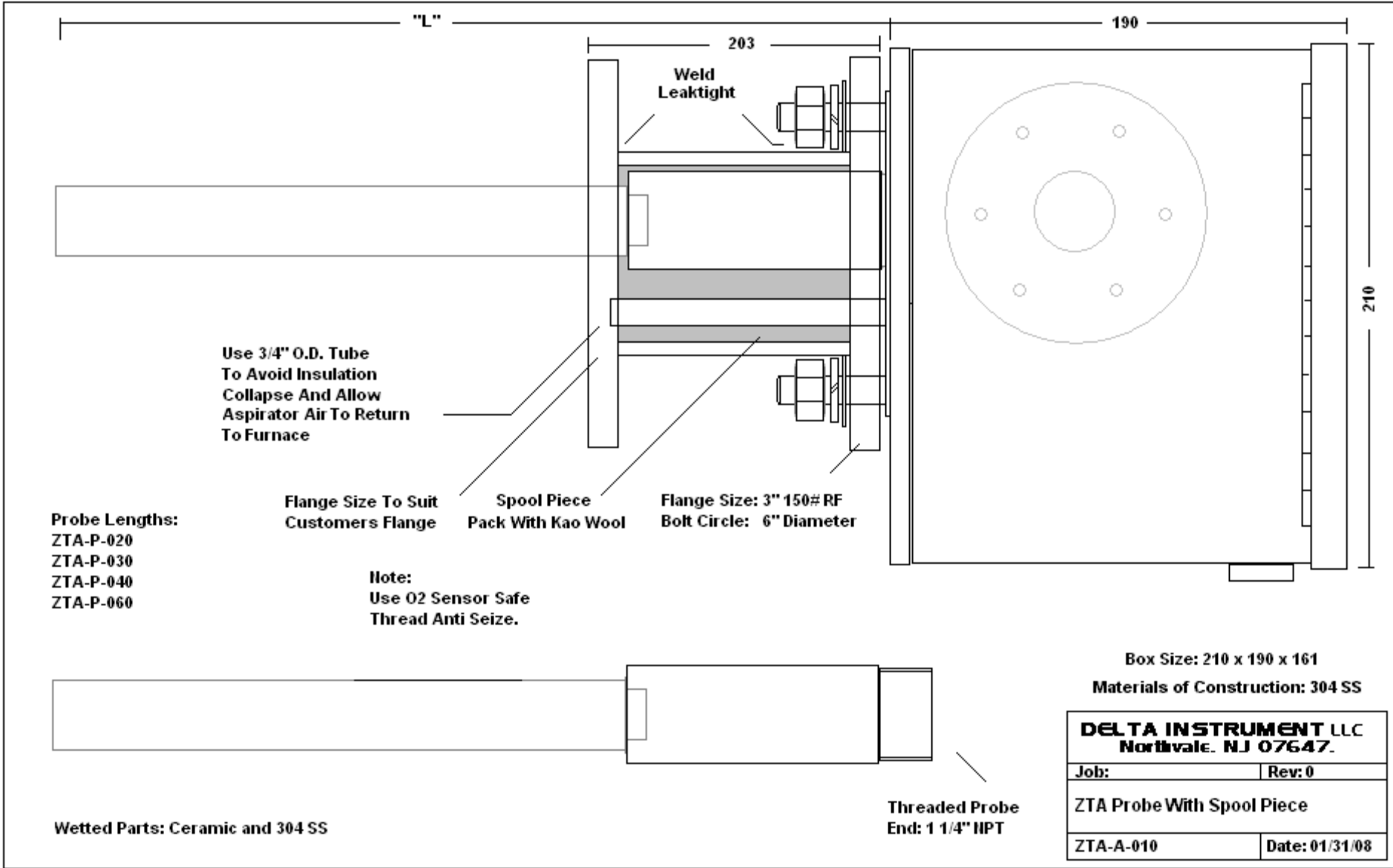

DELTA INSTRUMENT LLC Northvale, NJ 07647.	
Job:	Rev: 0
ZTA Probe With Spool Piece	
ZTA-A-010	Date: 01/31/08

Flange Size: 2" 150# RF
 Bolt Circle: 4.75" Dia
 Flange Dia: 6"

6 x 5mm x 14 mm
 Hex Cap Screws

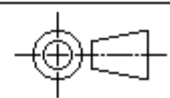

Probe Lengths in Inches:
 L = 12, 20, 30, 40.

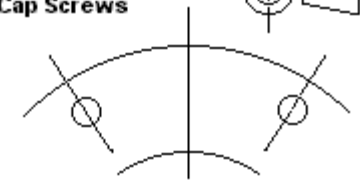
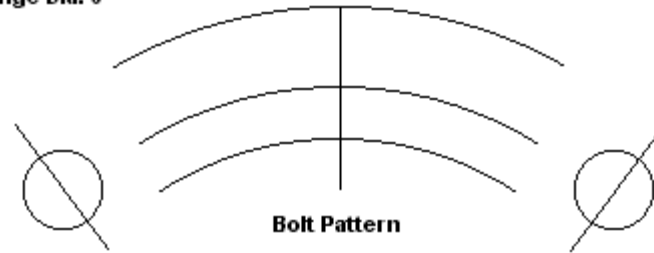

Bolt Pattern

Length in Inches

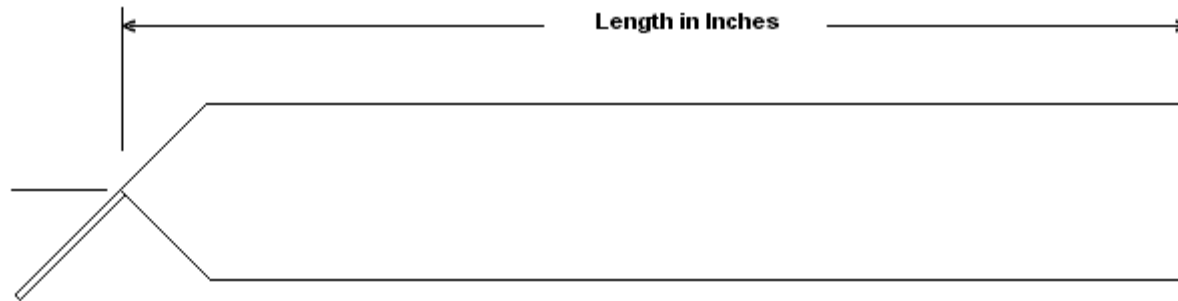

Side View

ZFK8 Oxygen Detector

1.9"



End View

Example Part Number:
 12" Long = ZFK-PS-012

Plug Open Port
 If 1/4" Cal Tube
 Is Not Connected
 - To Avoid Any
 Air Inleakage -



Materials of Construction: 304 SS

DELTA INSTRUMENT LLC Northvale, NJ 07647.	
Job:	Rev: 0
ZFK - Probe (Special) 2" 150# Flange	
ZFK-PS-XXX - 00	Date: 01/11/23

